

QST

July, 1937
25 cents

devoted entirely to
**amateur
radio**

In this issue—
**Building a
Ladder Must
More About
Noise
Silencing**



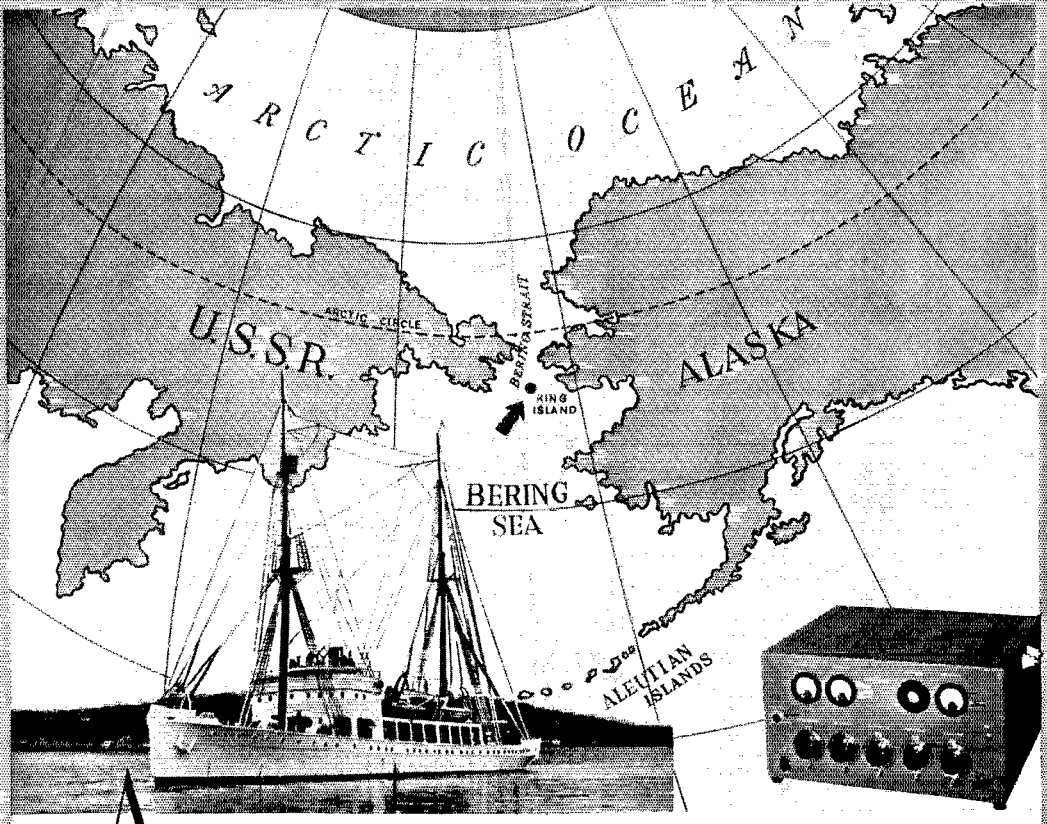

AFTER careful investigation, Father Hubbard chose Collins as the outstanding radio equipment. A Collins 32G, 40 Watt Transmitter was selected by the "Glacier Priest" to contact the outside world during his year and a half stay on bleak, frozen King Island in the Arctic. From there will be transmitted scientific reports, weather data and news stories. This region is the birth-place of the Arctic's fiercest storms, and is a most rigid proving ground for a transmitter. The expedition will be conveyed by the United States Coast Guard Cutter "Northland," which has likewise been Collins equipped for broadcasting.

COLLINS RADIO COMPANY
CEDAR RAPIDS, IOWA

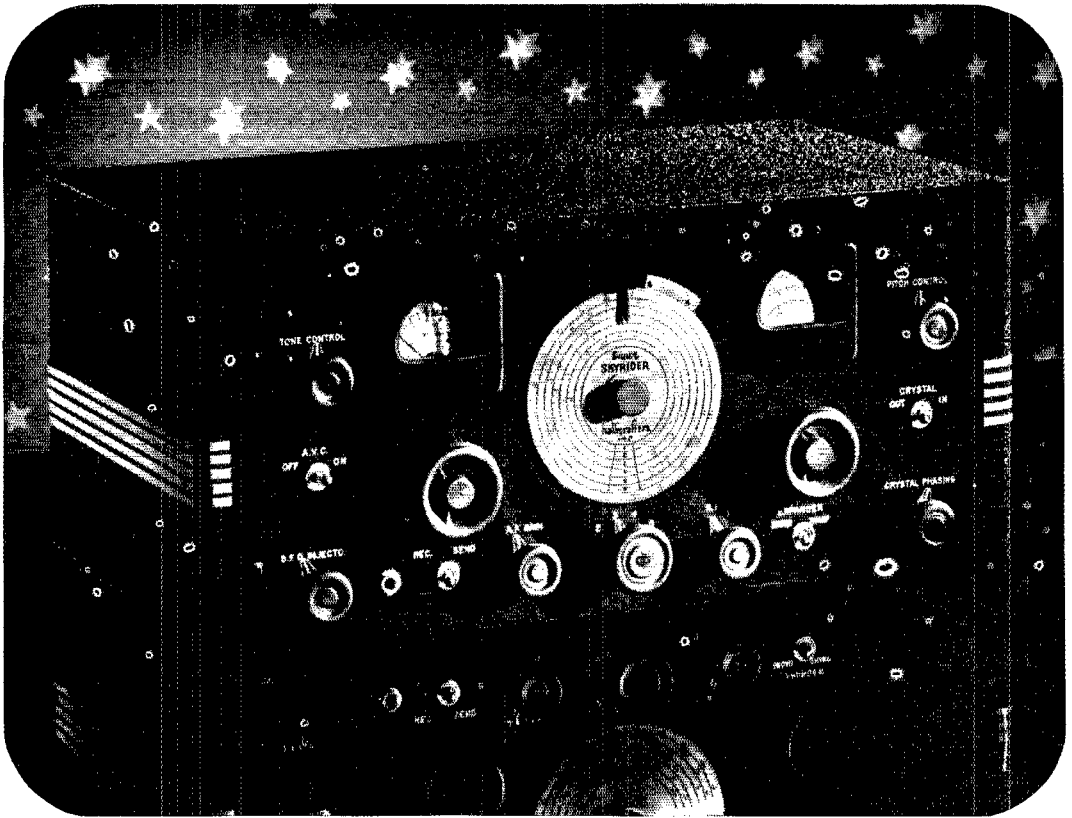

What is a COMMUNICATIONS RECEIVER?

It's more than just a "short wave" receiver! A communications receiver is primarily designed for efficient "high frequency" reception, not for broadcast — a rugged, "scientific," precision-built job designed to operate at high efficiency under adverse conditions and in emergencies.

Who can design such receivers? Obviously the engineers who use them as their own hobby — and *know* what they should be!

Such men predominate in the Hallicrafters organization. Here is a group of engineers who are amateurs and have been amateurs for years — most of them from the days of spark transmitters and crystal detectors.

Today they are building fine communications receivers — making their fascinating avocation a life-work and a livelihood — and putting into them all the enthusiasm and craftsmanship they lavish on their personal equipment.

Because of their extensive, intimate experience with amateur problems, and because of their excellent research and experimental facilities, the Hallicrafters can make such revolutionary developments as the incorporation of an efficient 5-meter band into the 1938 Super Sky Rider, to mention but one of many such developments pioneered by this organization.

Then too, Hallicrafters receivers are fully licensed, thus placing at the disposal of the Hallicrafters, the developments of a whole generation of leading radio engineers.

When you purchase a Hallicrafters' receiver, you are not only buying a fine precision-built instrument, but the product of a group of engineers whose pride and life-work are represented by that receiver.

Ask your dealer about the Hallicrafters' Time Payment Plan

Send for illustrated booklet completely describing the New 1938 Super Sky Rider

the hallicrafters inc.
2615 INDIANA AVENUE, CHICAGO
CABLE ADDRESS "HALLICRAFT"

"America's Leading Manufacturers of Communications Receivers"

Say You Saw It in *QST* — It Identifies You and Helps *QST*

THE SUPER SKY RIDER

the NEW 1938 SUPER SKY RIDER



Entirely New- WITH NEW FEATURES AND
EVEN FINER PERFORMANCE THAN BEFORE!

Match These Features If You Can

- ★ 5 to 550 Meters Coverage
- ★ 6 Bands
- ★ 11 Tubes
- ★ Wide Range Variable Selectivity
- ★ Better than One Microvolt Average Sensitivity on all bands
- ★ 1000° Electrical Band Spread
- ★ "S" Meter
- ★ 13 Watt Undistorted Output
- ★ Air-Trimmed R.F. Circuit
- ★ Improved Expanding I.F. Transformers
- ★ Improved Crystal Filter Control

We've never before seen such a receiver as the one that's just been announced! But we can't wonder, for we have never before seen one that offers so much in the way of new features, performance and in real value!

Complete coverage from 5 to 550 meters without a gap! Not only all the amateur bands, including the interesting and exciting new 5 meter band, but everything from there to the top of the broadcast band all in one highly sensitive, super-selective receiver.

1000° of band spread! Feature that on the crowded amateur bands of today! You can really spread 'em out with the 1938 Super!

Wide range variable selectivity! Razor sharpness to broad high fidelity. We could go on and on, but it's better if you see for yourself. Come in and try it out, or if you can't do that, drop us a line and we will send you the complete specifications.

and what a value **\$99.00**
at less speaker
less crystal

Available on Hallicrafters
Time Payments

STOP IN TO SEE IT, OR WRITE TODAY FOR COMPLETE DETAILS

**CONSOLIDATED
RADIO CORPORATION**
612 ARCH ST., PHILADELPHIA, PA.

the hallicrafters inc.

THE SKY BUDDY THE SKY CHIEF THE ULTRA SKY RIDER

THE SKY RIDER COMMERCIAL THE SKY CHALLENGER

QST

devoted entirely to

AMATEUR RADIO

PUBLISHED, MONTHLY, AS ITS OFFICIAL ORGAN, BY THE AMERICAN RADIO RELAY LEAGUE, INC., AT WEST HARTFORD, CONN., U. S. A.; OFFICIAL ORGAN OF THE INTERNATIONAL AMATEUR RADIO UNION

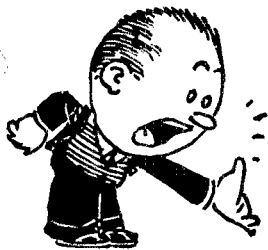

JULY
1937

Volume XXI
Number 7



Kenneth B. Warner (Secretary, A.R.R.L.), *Editor-in-Chief and Business Manager*; Ross A. Hull, *Associate Editor*; James J. Lamb, *Technical Editor*; George Grammer, *Assistant Technical Editor*; Clark C. Rodimon, *Managing Editor*; David H. Houghton, *Circulation Manager*; Ralph T. Beaudin, *Assistant Circulation Manager*; F. Cheyney Beekley, *Advertising Manager*; Charles Brunelle, *Assistant Advertising Manager*.

Editorial and Advertising Offices

38 La Salle Road
West Hartford, Connecticut

Subscription rate in United States and Possessions and Canada, \$2.50 per year, postpaid; all other countries, \$3.00 per year, postpaid. Single copies, 25 cents. Foreign remittances should be by international postal or express money order or bank draft negotiable in the U. S. and for an equivalent amount in U. S. funds.

Entered as second-class matter May 29, 1919, at the post office at Hartford, Connecticut, under the Act of March 3, 1879. Acceptance for mailing at special rate of postage provided for in section 1103, Act of October 3, 1917, authorized September 9, 1922. Additional entry at Concord, N. H., authorized February 21, 1929, under the Act of February 28, 1925.

Additional second-class entries to cover sectional editions authorized March 20, 1935. Copyright 1937 by the American Radio Relay League, Inc. Title registered at United States Patent Office.

The Contents

Editorial	7
W8DPY Wins Paley Award	8
Recording Ultra-High-Frequency Signals Over Long Indirect Paths — Part II	Ross A. Hull 10
See-Saw Noise Silencer <i>B. S. McCutchen and D. A. Griffin, W2AOE</i>	13
A Fundamental-Reinforced Harmonic-Generating Circuit <i>John L. Reinartz, W1QP</i>	15
A New Type of Skyhook — The Ladder Mast <i>James Millen, W1HRX</i>	16
New Beam Power Transmitting Tubes	RK-47, RK-48 18
An Effective Linear Filter for Harmonics <i>J. N. A. Hawkins, W6AAR</i>	19
Candid Shots of the 1937 Board Meeting	20
What the League Is Doing	21
A Four-Band Portable or Mobile Transmitter <i>Frank Jacobs, W2BSL</i>	23
How Would You Do It?	25
56 Mc. Shoots the Works	27
Dixie Jones' Owl Juice	27
Note on Reduction of Distortion and Noise with Inverse Feedback	28
Improving DX	29
W3FAR Wins 28-Mc. Contest	29
A Simple Bread-Board Crystal-Controlled Transmitter for 56 Mc.	Harry A. Gardner, W1EHT 30
High Capacity Midget Switches	31
Hints and Kinks	32
IARU News	34
MRAC-ARRL 56-Mc. Cup Announcement	35
Operating News	36
Correspondence Department	44
Midwest Division Convention	60
Oklahoma State Convention	66
Silent Keys	66
Standard Frequency Transmissions	70
New Tuning Indicator Tubes	74
License or Chart Holder	74
Hamads	91
QST's Index of Advertisers	94

“HATS OFF TO A GRAND SET—

THE *New* ‘SUPER-PRO’”



* “THE most efficient receiver we have ever used,” says William Greer, chief engineer of WNEL, Porto Rico. Mr. Greer adds, “We have tried several radio receivers, all of them considered to be well designed and constructed, but the Hammarlund “Super-Pro” is the only set that we have been able to use in the transmitting plant to pick up the signals of WABV, for rebroadcasting. Before purchasing the “Super-Pro” it was necessary to locate the receiver some distance from WNEL and then make use of lines to the transmitter. The “Super-Pro” does not seem to be as susceptible to the high noise level and conditions which ordinarily result in cross-talk as the other receivers we have used. The antenna used is a 30 foot doublet located about 70 feet from the antenna of WNEL. No attempt was made to filter the 1290 kc. frequency of WNEL out of the receiver input.

Yet it was possible to receive stations in the United States whose field intensity could not have been more than a few micro-volts, and whose frequencies

were separated from WNEL'S by a few kilocycles.”

The “Super-Pro” receivers provide such exceptional efficiency because they have such features as — calibrated band width, beat oscillator, audio and sensitivity controls; stand-by switch; relay terminal strip; A.V.C.-Manual control; C.W.-Mod. switch; 8 metal and 8 glass tubes; separate humless power supply; trouble-free cam switch, and a host of other notable improvements. Crystal or standard models for 1.25 to 40 mc. and .54 to 20 mc., for table or rack mounting are available.

All the features are completely described and illustrated in the new “Super-Pro” bulletin. Mail coupon below today for your copy!

HAMMARLUND MFG. CO., INC.
424-438 W. 33rd St., N. Y. City

- Please send me new “Super-Pro” bulletin.
- Please send me new “37” catalog.

Name.....
Address.....
City..... State..... Q-7

★ SEND
FOR THIS
BULLETIN!



HAMMARLUND

Section Communications Managers of the A.R.R.L. Communications Department

All appointments in the League's field organization are made by the proper S.C.M., elected by members in each Section listed. Mail your S.C.M. (on the 10th of each month) a postal covering your radio activities for the previous 30 days. Tell him your DX, plans for experimenting, results in 'phone and traffic. He is interested, whether you are an A.R.R.L. member or get your QST at the newsstands; he wants a report from every active ham. If interested and qualified for O.R.S., O.P.S. or other appointments he can tell you about them, too.

Eastern Pennsylvania Maryland-Delaware-District of Columbia Southern New Jersey Western New York Western Pennsylvania	W3EZ W3BAK W9QG W8DSS W8OFO	ATLANTIC DIVISION James M. Bruning Edgar L. Hudson Noble Burkhardt Charles Smith Kendall Speer, Jr.	339 W. Lancaster Ave. 1107 Park Ave. 310 E. Walnut St.	Haverford Laurel, Delaware Oneida Lowber
Illinois Indiana Kentucky Michigan Ohio Wisconsin	W9KJY W9AG W9AJH W8DPE W8AQ W9ATO	CENTRAL DIVISION L. John Huntoon G. W. Mossbarger Harold C. Bird E. H. Gibbs E. A. Cary	327 Brandon Ave. R. 4, Box 1 Box 177 R.F.D. 2 300 High St. 3922 No. 19th Pl.	Glen Eilyn Indianapolis Camp Taylor Pontiac Wadsworth Milwaukee
North Dakota South Dakota Northern Minnesota* Southern Minnesota	W9RZA W9SEB W9IGZ W9DCM	DAKOTA DIVISION Ernest Bloch Andrew J. Kjar Edwin L. Wicklund Webster F. Soules	Box 202 221 West Prospect Ave. R. F. D. 3 3549 36th Ave., So.	Thompson Pierre Kensington Minneapolis
Arkansas Louisiana Mississippi Tennessee	W5ABI W5DKR W5CWO W4DEP	DELTA DIVISION H. E. Velte Eugene H. Treadaway J. H. Weems, Jr. B. G. Lowrey Smith	4415 West 12th St. 2749 Myrtle St. P. O. Box 244 673 Hillcrest St.	Little Rock New Orleans State College Memphis
Eastern New York N. Y. C. & Long Island Northern New Jersey	W2LU W2AZV W2GMN	HUDSON DIVISION Robert E. Haight E. L. Baunach Fred C. Read	511 South Holmes St. 102 Central Ave. 1014 North Ave.	Scotia Massapequa, L. I. Elizabeth
Iowa Kansas Missouri Nebraska	W9NNM W9PB W9CJR W9FAM	MIDWEST DIVISION Owen Williams Harry E. Legler J. Dewey Mills Samuel C. Wallace	108 No. Johnson St. 304 Miami St. Box 205 Green St.	Iowa City Hawatha Mount Vernon Clarks
Connecticut Maine Eastern Massachusetts Western Massachusetts New Hampshire Rhode Island Vermont	W1CTI W1FBI W1ABG W1JAH W1BFT W1HRC W1GNF	NEW ENGLAND DIVISION Frederick Ella, Jr. Winfield A. Ramsdell Albert N. Giddis William J. Barrett Carl E. Evans Clayton C. Gordon Alvin H. Battison	19 Merrill Rd. 1188 Washington Ave. 128 Crawford St. 239 Columbia St. 80 No. State St. 192 Washington Ave. 1 Central St.	Norwalk Portland Lowell Adams Concord Providence Windsor
Alaska Idaho* Montana Oregon Washington	K7PO W7EMT W7CRH W7AJV W7WY	NORTHWESTERN DIVISION Richard J. Fox Carl Elchebberger Russell U. Richmond Eugene E. Lovejoy Robert H. Votaw	Box 301 2810 North 6th St. 5013 N. E. Clackamas Route 1, Box 398	Ketchikan Boise Somers Portland Vancouver
Hawaii Nevada Santa Clara Valley East Bay San Francisco Sacramento Valley Philippines San Joaquin Valley	K6AJA W6BIC W6FBW W6JTV W6SG W6DVE KA1GR W6LPE	PACIFIC DIVISION Otis Hill Edward W. Heim Elbert. Amarantes Harold J. Burchfield Alan D. Whittaker, Jr. Geo. L. Woodington George L. Rickard Angelo V. Astone	Box 952 509 Claremont St. 475 So. 11th St. 2240 106th Ave. 79 Elinor Ave. 716 Redwood Ave. Box 849 729 Safford	Hilo Reno San Jose Oakland Mill Valley North Sacramento Manila Fresno
North Carolina South Carolina Virginia West Virginia	W4OG W3UVA W8KKG	ROANOKE DIVISION H. S. Carter Charles M. Waff, Jr. Dr. Wm. H. Riheldaffer	P. O. Box 111 P. O. Box 1212	Winston-Salem Univ., Charlottesville Lost Creek
Colorado Utah-Wyoming	W9FA W7COH	ROCKY MOUNTAIN DIVISION Glen Glasscock Townsend J. Rigby	2164 So. Corona St.	Denver Midwest, Wyoming
Alabama Eastern Florida Western Florida Georgia-Cuba-Isle-of-Pines- Porto Rico-Virgin Islands	W4DGS W4ASR W4BSJ *W4PM	SOUTHEASTERN DIVISION James F. Thompson William C. Shelton Ellis R. Curry Charles W. Davis	2248 S. Arlington Ave. 556 Westmoreland Drive "Hillcrest", P. O. Box 652 Box 425 2136 NE Boulevard Dr.	Birmingham Daytona Beach Madison Atlanta, Ga.
Los Angeles Arizona San Diego	W6GXM W6LVG W6EOP	SOUTHWESTERN DIVISION Don M. Draper C. C. Day Harry A. Ambler	4421 West 63 St. "La Posta Quemada" 4101 Hamilton St.	Los Angeles Vail San Diego
Northern Texas Oklahoma Southern Texas New Mexico	W5BII W5CEZ W5BDI W5CGJ	WEST GULF DIVISION Richard M. Cobb Carter L. Simpson Ammon O. Young Joseph M. Eldodt	Box 185 2010 So. 4th St. 4803 Eli St.	Dodd City Ponca City Houston Chamita
Maritime	VE1DQ	MARITIME DIVISION A. M. Crowell	69 Dublin St.	Halifax, N. S.
Ontario	VE3SG	ONTARIO DIVISION Fred H. B. Saxon	302 Lee Ave.	Toronto, Ont.
Quebec	VE2EE	QUEBEC DIVISION Stan Comach	780 Brault Ave.	Verdun, P. Q.
Alberta British Columbia	VE4LX VE5EP	VANALTA DIVISION Alfred D. Kettenbach D. R. Vaughan-Smith	1221 Burnaby St.	Rockyford Vancouver
Manitoba Saskatchewan	VE4BG VE4EL	PRAIRIE DIVISION A. J. R. Simpson Wilfred Skalfe	635 Garfield St. 2040 McTavish St.	Winnipeg Regina

* Officials appointed to act until the membership of the Section choose permanent S.C.M.'s by nomination and election.

The American Radio Relay League



THE AMERICAN RADIO RELAY LEAGUE, INC., is a non-commercial association of radio amateurs, bonded for the promotion of interest in amateur radio communication and experimentation, for the relaying of messages by radio, for the advancement of the radio art and of the public welfare, for the representation of the radio amateur in legislative matters, and for the maintenance of fraternalism and a high standard of conduct.

It is an incorporated association without capital stock, chartered under the laws of Connecticut. Its affairs are governed by a Board of Directors, elected every two years by the general membership. The officers are elected or appointed by the Directors. The League is non-commercial and no one commercially engaged in the manufacture, sale or rental of radio apparatus is eligible to membership on its board.

"Of, by and for the amateur," it numbers within its ranks practically every worth-while amateur in the nation and has a history of glorious achievement as the standard-bearer in amateur affairs.

Inquiries regarding membership are solicited. A bona fide interest in amateur radio is the only essential qualification; ownership of a transmitting station and knowledge of the code are not prerequisite. Correspondence should be addressed to the Secretary.

HIRAM PERCY MAXIM, FIRST PRESIDENT

OFFICERS

President.....EUGENE C. WOODRUFF, W8CMP
State College, Pa.

Vice-President.....GEORGE W. BAILEY, W1KH
Weston, Mass.

Secretary.....KENNETH B. WARNER, W1EH
West Hartford, Connecticut

Treasurer.....ARTHUR A. HEBERT, W1ES
West Hartford, Connecticut

Communications Mgr....F. EDWARD HANDY, W1BDI
West Hartford, Connecticut

General Counsel.....PAUL M. SEGAL
1010 Shoreham Building, Washington, D. C.

DIRECTORS

President
EUGENE C. WOODRUFF.....W8CMP
234 W. Fairmount Ave., State College, Pa.

Vice-President
GEORGE W. BAILEY.....W1KH
74 Webster Road, Weston, Mass.

Canadian General Manager
ALEX REID.....VE2BE
169 Logan Ave., St. Lambert, P. Q.

Atlantic Division
WALTER BRADLEY MARTIN.....W3QV
Box 612, Rostlyn, Pa.

Central Division
R. H. G. MATHEWS.....W9ZN
100 East Ohio St., Chicago

Dakota Division
CARL L. JABS.....W9BVH
1822 James St., St. Paul, Minn.

Delta Division
E. RAY ARLEDGE.....W5SI
P. O. Box 286, Pine Bluff, Ark.

Hudson Division
KENNETH T. HILL.....W2AHC
115 Willow St., Douglaston, L. I., N. Y.

Midwest Division
FLOYD E. NORWINE, JR.....W9EFC
120 South Fourth St., St. Louis, Mo.

New England Division
PERCY C. NOBLE.....W1BVR
37 Broad St., Westfield, Mass.

Northwestern Division
RALPH J. GIBBONS.....W7KV
c/o United Air Lines, Pendleton, Ore.

Pacific Division
S. G. CULVER.....W6AN
2962 Russell St., Berkeley, Calif.

Roanoke Division
H. L. CAVENESS.....W4DW
State College Station, Raleigh, N. C.

Rocky Mountain Division
EDWARD C. STOCKMAN.....W9ESA
618 So. Williams St., Denver

Southeastern Division
BENNETT R. ADAMS, JR.....W4APU
1512 Grove Place, Homewood, Ala.

Southwestern Division
CHARLES E. BLALACK.....W6GG
443 Main St., El Centro, Calif.

West Gulf Division
WAYLAND M. GROVES.....W5NW
c/o Humble Pipe Line, Talco, Texas

Address all general correspondence to the administrative headquarters at West Hartford, Connecticut



THE EDITOR'S MILL

ONE of the most important actions of the Board of Directors of the League at its annual meeting last spring was in instructing the Communications Manager to coordinate a study, along engineering lines, of the possibilities of making a better planned use of our bands. With the advice of the division directors he is to form a group of collaborators, then digesting the available ideas in this field with the aid of the technical staff of *QST*, and reporting the results to the Board for its meeting next year.

There is growing amateur recognition that for improvement in our operating position we have now to look within our own structure of allocations. Technically we have made marvelous strides in more stable transmitters and more selective receivers. There is still room for technical development in 'phone operation but there seems to be very little more in sight to give c.w. additional relief by technical means. However, there is an increasing feeling that much could be accomplished by a more intelligent use of our present assignments, particularly in the form of an engineering system for the use of our bands for different purposes.

Our present allocation system is not a bad one, but it must be admitted that it has "just grown." We commented on this subject on this page last October. It all revolves about the fundamental theme that it is rather foolish of us as individual amateurs to insist that any amateur ought to be permitted to use any frequency at any time for any purpose over any distance. Certainly we all enjoy our rights and our liberty of action, but it seems quite possible that a few mutual concessions would improve the operating lot of every one of us.

Suppose the day had two hundred and forty hours and you had a kilowatt of c.w. and 'phone on every band, and nothing else to do but operate. Suppose you were thoroughly acquainted with conditions on every band, and knew all the separate "gangs." Suppose you accumulated a lot of ideas as to the best purposes for each band, and just where each branch of our service could best work. Then suppose that you were absolute dictator of amateur radio. How would you employ the bands, what branches of amateur radio

would you put in each, where would 'phone go, and so on? This is a fascinating subject for every serious and well-informed amateur. It is well worth a lot of study. There is no particular reason why we should be bound by anything that has happened in the past. Some rainy Sunday afternoon when the power has gone off you might draw yourself a picture of the amateur bands in their harmonic relations and do a little "supposing."

Isn't it a little absurd that our various 'phone bands are not in harmonic relationship? What about the possibilities of some sort of an international agreement in the I.A.R.U. to subdivide the DX bands so that foreigners would be in some portions of the bands in which we would agree to refrain from transmitting, so that we could work them without interference from other W's and VE's and XE's? Certain bands for relay traffic, to be sure. Places for Army and Navy drills. Perhaps definite assignments for QRR work. Some rules against employing busy or DX bands for cross-town work. A scheme to minimize h.c.l. interference from Class B 'phones. What to do with 1715-1750? Deciding whether beginners ought to be "confined" somewhere during a probationary period. Providing not only for the distinction between 'phone and c.w. but for that between traffic, rag-chewing, emergencies and experimental work. And bearing in mind all the time the desirability of harmonic relationship between the different sub-bands used by the same kind of service. Remembering, too, the difference in ranges and how these vary between day and night and from season to season.

This is to be the field of study of the Communications Manager's new group. It seems to us the most pressing problem, and at the same time the most interesting one, of our day. Leaning heavily on engineering considerations, and divorced from "amateur politics," it ought to yield us some important suggestions. Perhaps it ought to be a continuing study that would go on from year to year, polishing up its plan as changes take place in the art. At any rate, we are making a start and we shall soon see, as the Board's minutes say, "whether the idea has large future value or not." We think it has.

K. B. W.

W8DPY Wins Paley Award

THE William S. Paley Amateur Radio Award for 1936 was presented to Walter Stiles, Jr., W8DPY, at a presentation luncheon in the Waldorf-Astoria Hotel in New York on May 24th.

This award, originally announced in the December 1936 issue of *QST*, is being presented annually by Mr. Paley, the youthful and brilliant president of the Columbia Broadcasting System, to "that individual who, through amateur radio, in the opinion of an impartial Board of Awards, has contributed most usefully to the American people, either in research, technical development or operating achievement." It is open to all amateur radio operators in the United States and Canada.

The presentation ceremonies, which were broadcast over the entire C.B.S. network at 2:30 P.M., sparkled with tributes to W8DPY and amateur radio as a whole. The principal address was by the Hon. Anning S. Prall, chairman of the F.C.C., while Mr. Paley, Mr. Stiles, and K. B.

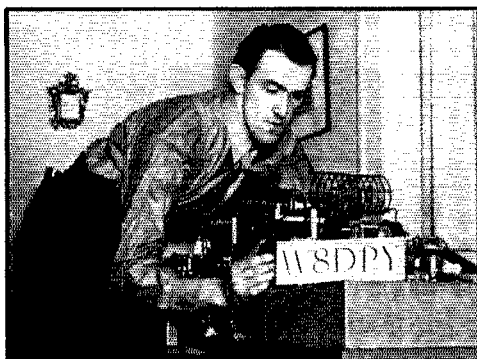

WALTER STILES, JR., TUNING UP THE BIG RIG AT W8DPY

Warner, managing secretary of A.R.R.L., were also heard. Mr. Prall's address is of such general interest that it is here reproduced in full:

Mr. Paley, Mr. Warner, ladies and gentlemen and fellow amateurs: I am glad to participate in this tribute to the amateur radio operators of America.

The award that to-day is being presented is not only a recognition of the heroic services of an individual. It likewise symbolizes the development and progress of a great service; a service of tremendous importance to the nation. The contribution of the amateurs to the radio art is not confined to the job they do in emergency communication. Since the early days of radio, the attics and basements of thousands of ingenious amateurs have served as laboratories from which have come many valuable technical improvements.

Following Marconi's first transatlantic transmission in 1901, the amateur radio movement developed rapidly. Solitary experimenters in one city became linked through the magic of radio to their fellow amateurs in other communities. And in the years just preceding the World War, the develop-

ment of amateur activity was so rapid that inevitable conflict developed with commercial and governmental radio activities. But by this time there were several thousand amateurs linked together through numerous radio clubs and, although not highly organized, they were able to gain a place in the radio spectrum, when in 1912 the first comprehensive federal radio law was enacted.

With the establishment of the American Radio Relay League in 1914 by the late Hiram Percy Maxim, the amateur groups were able to expand and survive under new regulations that necessarily followed the rapid development of radio. So successful was the encouragement given to amateurs during this formative period that, when America entered the World War, amateurs were able to provide some four thousand trained radio operators to the military service. This gave the United States the most competent radio corps of any of the nations and they unquestionably played an important part in attaining victory. To-day wherever the American flag flies, there are radio amateurs whose technical qualifications and equipment meet the conditions of the licenses. Only last week an application was received by the Federal Communications Commission for a license to an operator in Wake Island. Many of you will recall that a licensed amateur accompanied Admiral Byrd to Little America and the programs originating there were re-broadcast over the facilities of the Columbia Broadcasting System. There are now licensed amateurs in all the states and territories. We have to-day approximately forty-seven thousand amateur radio operators licensed by the Commission. They are definitely an important part of the American radio system and constitute about three-fourths of the amateurs of the world. They stand ready as a reserve corps, these emergency sentinels of the air, to perform whatever service the nation may require. Peacetime emergencies find them ready and competent to discharge important duties, and in the event of war this nation would again have trained personnel which would provide the most efficient communication corps of any nation in the world.

As Chairman of the Federal Communications Commission, I wish to assure the forty-seven thousand amateur radio operators of this country of our sustained interest in their problems and their continued welfare. The Commission has always maintained and I think will continue to maintain a liberal attitude toward the amateurs. We recognize that the service they have performed and can perform in the future is one of our country's great assets. We will continue to encourage the development of the amateur movement. I wish to tender my congratulations to Walter Stiles, Jr., of Pennsylvania, whose conspicuous service during the disastrous flood of March 1936 has brought him this distinguished award. And through Mr. Stiles, I desire to salute the thousands of other amateur radio operators who have from time to time rendered similar distinctive services.

Following this address, Mr. Paley presented a replica of the award to W8DPY, with a citation

President Roosevelt Congratulates W8DPY

The following is the text of a telegram received from The White House by Walter Stiles, Jr., following announcement of his winning of the Paley award:

"I have learned of the splendid services you performed as an amateur radio operator during the flood emergency of March 1936 and desire to congratulate you upon the fine work which you accomplished. What you were able to do in aid of the flood sufferers emphasizes how important the continued development of amateur radio activity is to the best interest of the nation.

"Sincerely yours, Franklin D. Roosevelt."

of the performance record which had earned him this outstanding recognition. Stiles, in acknowledging the trophy, stated that he did so "with great humility" and the feeling that it was being given him "merely as a representative of the great army of hams whose world knows no boundary and whose proudest and happiest moments are when they are able to alleviate distress and disaster."

Thereupon Mr. Paley entrusted to Secretary Warner, on behalf of the A.R.R.L., the permanent award, of which the League is to act as permanent custodian. In doing so he said that he had "long looked forward to this opportunity to honor your splendid organization, which is doing such a continuously constructive service in the field of radio operations and which has given to present-day broadcasting much of the stimulus responsible for its tremendous growth and development." Warner, in his acknowledgment, expressed the gratitude and appreciation of the amateur fraternity to Mr. Paley and the Columbia System, and congratulated W8DPY.

Selection of Stiles for the award was made by a distinguished Board of Judges, comprising Rear Admiral Cary T. Grayson, chairman of the American Red Cross; the Hon. C. P. Edwards, director of radio for the Canadian Department of Marine; the Hon. Anning S. Prall; Dr. J. H. Dellinger, chief of the Radio Section of the U. S. Bureau of Standards; and Professor A. E. Kennelly, professor emeritus of electrical engineering at Harvard University. Stiles, who was originally nominated for the award by the A.R.R.L., was chosen from a total of 40 nominees.

W8DPY's selection for the award was on the basis of his performance during the March 1936 flood emergency. When on Wednesday, March 17th, of last year the Allegheny River reached flood stage at Coudersport, his home, he decided that a major flood emergency was in the making and, being a member of the A.R.R.L.'s Emergency Corps, he started assembling his portable equipment. This consisted of a National ACSW-3, a re-vamped Collins 4-A transmitter, and a gasoline-driven 5-kw. generator and associated gear. Throughout that night flood traffic was handled at the permanent station, this operation continuing until 9:30 Thursday morning when an urgent plea for aid came from an amateur station at a C.C.C. Camp near Renova, Pa. The message stated that Renova was isolated and in dire need of food, clothing and medical supplies. Stiles attempted to telephone the message to the Governor at Harrisburg, but the telephone lines

were down. It was eventually delivered, but in the meantime a meeting of the local Coudersport Red Cross chapter was hurriedly called and a relief expedition organized. By 6 p.m. large quantities of medical and other supplies were

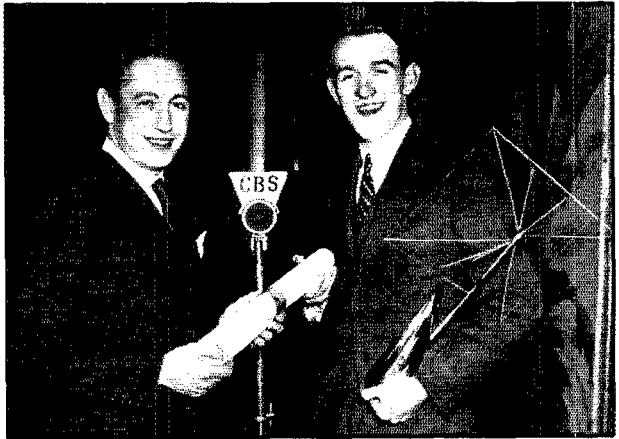

WILLIAM S. PALEY, PRESIDENT OF C.B.S., PRESENTS HIS ANNUAL AMATEUR RADIO AWARD TO WALTER STILES, JR. W8DPY, 1936 WINNER

Stiles has a replica of the award in his hand. The permanent award, a massive man-size affair of striking beauty, is on display at A.R.R.L. Hq., its permanent custodians. The design is due to Alexander Calder, internationally recognized young American sculptor and foremost exponent of the new "mobilitist" school. It is made of bright stainless steel, and typifies a lightning bolt, radio antennae, and world-wide amateur communication. Other of Calder's works are on display at the Smithsonian in Washington, John Herron Art Institute in Indianapolis and the New York Metropolitan Museum of Art.

packed on a C.C.C. truck, with W8DPY's portable rig on top, and the party set off.

The 68 miles of dirt road from Coudersport to Renova skirt the river all the way. Few who watched the rescue crew depart from Coudersport expected them to reach their destination. For miles the road was covered with flood waters. Bridges were out; they were replaced by improvised planking. Washouts threatened from below, landslides from overhead. Temporary roads had to be dug out of the mountain sides. Yet at 1:30 the next morning the party arrived at a point only five miles from stricken Renova.

There a mountain landslide had washed the road ahead into the river. Stiles got out of the truck, took off his clothing, and plunged into the swift, cold current to seek a possible footing for transporting supplies and radio equipment on the backs of the crew. Finding no bottom, he climbed out and blazed a trail around the landslide over the steep mountain slope. By 5:00 A.M. the crew of C.C.C. boys had carried the radio equipment into town on stretchers; and by 5:30, after pouring water out of the cabinets and setting up the gear on the Y.M.C.A. steps, W8DPY was on the air.

(Continued on page 76)

Recording Ultra-High-Frequency Signals over Long Indirect Paths

A Description of the Receiving and Record-Analyzing Equipment

By Ross A. Hull*

Part Two**

Hull's story of his work in recording ultra-high-frequency signals and the relationships he has observed between their behavior and the prevailing air masses constituted the first part of this series. Now we have the description of some of the equipment, presented in the hope that others will look it over, plan something similar and start recording some available u.h.f. broadcast signal (of which there are now plenty). In articles planned for the early future Hull will discuss some of the problems of calibrating the equipment and will outline some of the quantitative results obtained.—EDITOR.

IN Part I of this series we suggested that investigation of the refraction field in ultra-high-frequency transmission was a study in which the amateur could make invaluable contributions. We repeat the suggestion that prolonged observation—preferably recording—of ultra-high-frequency signals received over long indirect paths in various parts of this country and other parts of the world would be of very great value, particularly if these observations were studied in conjunction with meteorological soundings made with airplanes or balloons somewhere in the general vicinity of the path. It is, of course, a subdivision of amateur activity which may seem at first glance to be not nearly so much fun as

routine two-way communication. On the other hand, it can be every bit as intriguing as the more conventional ultra-high-frequency work and, without any doubt, is more likely to result in a contribution of general importance to the art.

We continue, then, with the description of the equipment used in this particular program with no suggestion that the apparatus is in any way an approach to perfection but merely offering it as the outcome of much practical cutting and trying.

The original receiver used for recording W1XW was a conventional SRR superregenerative receiver fitted with an r.f. stage and the audio output driving a rectifier type voltmeter included in the photographic recorder. This receiver proved fairly satisfactory for recording the modulated signal transmitted but it had many faults. In spite of the r.f. amplifier stage, heavy rain, and more particularly, ice on the antenna and transmission lines still influenced the loading of the detector sufficiently to upset its sensitivity appreciably. Also, the frequency stability was inadequate, tuning having to be checked at least four or five times each day.

In spite of these weaknesses, this set-up provided us with some eighteen months of continuous recording with relatively few periods that had to be disregarded because of mistuning. The only difficulty was that the equipment could not be left to look after itself for

more than half a day or so.

The logical development was to use crystal control in the transmitter and some type of

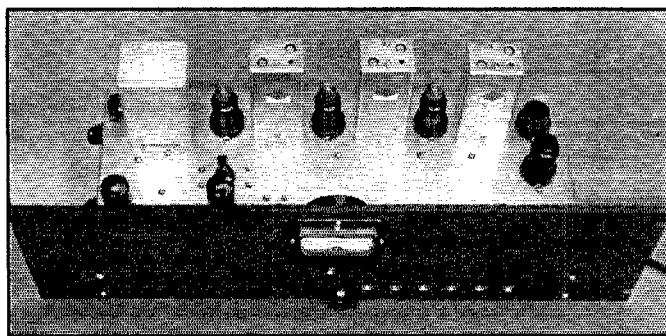

FIG. 1—A PLAN VIEW OF THE CRYSTAL-CONTROLLED ULTRA-HIGH-FREQUENCY RECEIVER BUILT ESPECIALLY FOR CONTINUOUS RECORDING

A low-drift or temperature-controlled crystal is used to insure freedom from frequency drift. This means, of course, that the receiver can only be returned to another signal frequency by changing crystals or by retuning the complete i.f. amplifier.

* Associate Editor.

** Part One of this series appeared in the May, 1937, issue.

superheterodyne receiver. Preliminary experiments with a conventional receiver indicated, however, that unless an exceptionally broad intermediate frequency amplifier was provided, the instability of even a carefully-built oscillator would result in much more serious tuning errors than had been experienced with the super-regenerative rig. In order to preserve a favorable signal-noise ratio it was decided to use a narrow band i.f. amplifier providing a crystal-controlled oscillator and appropriate frequency multipliers. This arrangement, with a simple constant-temperature oven for the crystal, proved eminently satisfactory and all our recording receivers are now planned along these lines. The resulting apparatus is relatively complicated but the reliability of its operation justifies the few extra hours of work involved in its construction.

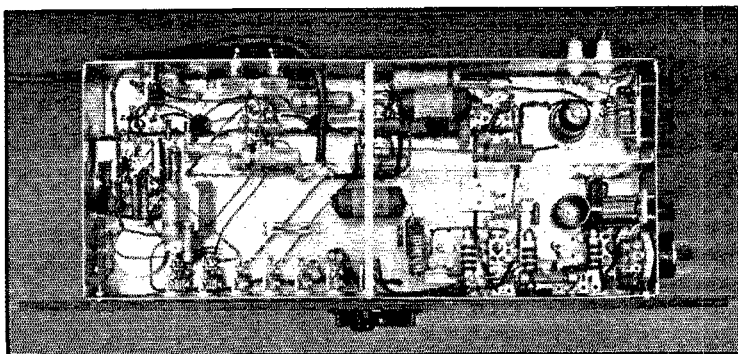

FIG. 2—UNDERNEATH THE CRYSTAL-CONTROLLED RECEIVER

The crystal oscillator and doublers are located at the right lower corner. Immediately above that section is the input r.f. amplifier tube mounted below the chassis to provide simple isolation of the grid and plate circuits. The row of jacks provides a means of rapidly checking the plate current of each tube in the receiver in the interest of quick fault-finding. The meter used in this work may also be switched into the a.v.c. circuit in order to permit visual monitoring of the signal level.

The receiver used for 41-Mc. recording consists of a simple glass tube converter (a 6C6), the oscillator grid being driven from the output of a 6D6 doubler excited from an 89 Tri-tet oscillator-tripler using a 7250-ke. crystal. The output from the crystal unit is therefore of 43.5 Mc. and the intermediate frequency resulting is 2500 kc. This i.f. frequency is fed to an HRO receiver—

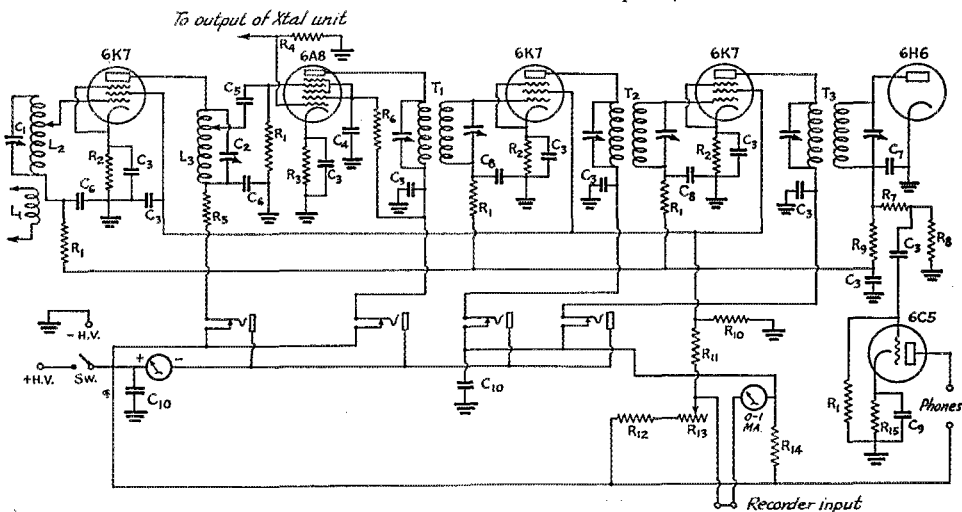

FIG. 3—THE CIRCUIT OF THE INTERMEDIATE FREQUENCY AMPLIFIER AND DETECTOR SECTION OF THE CRYSTAL-CONTROLLED RECEIVER

- C₁, C₂—15- μ fd. ultra Midget condensers.
- C₃—0.01- μ d. paper condenser.
- C₄—0.01- μ fd. paper condenser.
- C₅—100- μ fd. mica condenser.
- C₆—250- μ fd. mica condensers.
- C₇—250- μ fd. mica condensers.
- C₈—0.01- μ d. paper condensers.
- C₉—10- μ fd. low-voltage electrolytic condenser.
- C₁₀—0.25- μ fd. paper condensers.
- R₁—0.5-megohm, 1/2-watt resistor.
- R₂—350-ohm, 1/2-watt resistor.
- R₃—500-ohm, 1/2-watt resistor.
- R₄—50,000-ohm, 1/2-watt resistor.
- R₅—2000-ohm, 1/2-watt resistor.

- R₆—15,000-ohm, 1-watt resistor.
 - R₇—50,000-ohm, 1/2-watt resistor.
 - R₈—250,000-ohm, 1/2-watt resistor.
 - R₉—1 megohm, 1/2-watt resistor.
 - R₁₀—30,000-ohm, 1-watt resistor.
 - R₁₁—20,000-ohm, 10-watt resistor.
 - R₁₂—2000-ohm, 2-watt resistor.
 - R₁₃—1000-ohm, variable resistor.
 - R₁₄—2000-ohm, 2-watt resistor.
 - R₁₅—1000-ohm, 1-watt resistor.
 - L₁—6 turns No. 18 enameled wire, 3/16-inch diameter.
 - L₂, L₃—8 turns No. 14 wire, 3/16-inch diameter.
- The i.f. transformers T₁, T₂, T₃ are Sickles iron-cored 1600-ke. transformers.

the final result being a triple detection super-heterodyne. Another receiver, used for simultaneous recording on the same frequency, has a somewhat similar converter and crystal oscillator unit but utilizes a standard broadcast receiver for the i.f. amplifier. In this case, the crystal

into these jacks and so to make the necessary connections.

The output circuit of the receiver includes a plain diode detector which supplies a.v.c. for the three r.f. amplifiers and audio voltage, driving a 6C5, for monitoring purposes. The circuit used for operating the recorder is borrowed directly from the HRO. It is a bridge arrangement with the plate current of the two i.f. amplifiers on one arm and the screen current of the three r.f. amplifiers on the other. Not shown on the circuit is a double-pole double-throw toggle switch with which the 1-mil meter is connected either in the plate current measuring circuit or in the a.v.c.

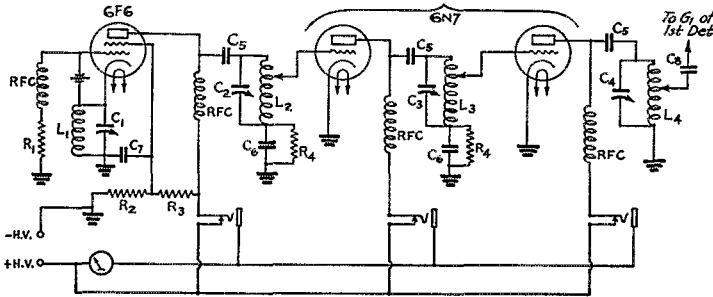

FIG. 4—THE CIRCUIT OF THE CRYSTAL OSCILLATOR AND FREQUENCY MULTIPLIER UNIT IN THE CRYSTAL-CONTROLLED RECEIVER

- C₁, C₂—75- μ fd. Midget variable.
- C₃—50- μ fd. Midget variable.
- C₄—35- μ fd. Midget variable.
- C₅—100- μ fd. mica condensers.
- C₆—250- μ fd. mica condenser.
- C₇—500- μ fd. mica condenser.
- C₈—100- μ fd. mica condensers.
- R₁—40,000-ohm, 1-watt resistor.
- R₂, R₃—50,000-ohm, 1-watt resistors.
- R₄—100,000-ohm, 1/2-watt resistor.
- L₁—21 turns No. 22 d.s.c. wire on a 1-inch diameter form, with no turns spacing.
- L₂—20 turns No. 22 d.s.c. wire on a 1/2-inch diameter former, with no turns spacing. Tap 5 turns from upper end.
- L₃—10 turns No. 14 wire, 5/8-inch inside diameter, self-supporting with turns spaced to occupy 1 1/4 inches. Tapped 3 turns from top end.
- L₄—7 turns No. 14 wire, 3/8-inch diameter with turns spaced to occupy 1 inch.
- RFC—National Type 100 choke.

frequency is so chosen that the difference frequency is of the order of 1500 kc.

A complete crystal-controlled receiver used for recording on 60.5 Mc. is shown in Figs. 1 to 4.

Though the entire equipment is built on a single chassis, the circuit is divided into two sections in order to simplify the presentation. From Fig. 3 it can be seen that the r.f. amplifier, the first detector and the i.f. amplifier are quite conventional in their circuit arrangement, the only innovation being a series of jacks functioning as switches to permit reading the plate current of any tube in the receiver. A piece of shafting fitted with a knob is used to insert

circuit. In the former position, the meter is shunted to give a full-scale reading of about 15 milliamperes.

The crystal section of the receiver, shown in Fig. 4, comprises a 6F6 Tri-tet crystal oscillator with the plate circuit tuned to four times the crystal frequency. The two sections of a 6N7 are then used as doublers to provide an output on 58.5 Mc. The i.f. amplifier is tuned to 1600 kc.—the frequency difference between the output of the crystal unit and the 60.6-Mc. signal.

The only problem in setting up the receiver is in adjusting the i.f. amplifier to the desired frequency. This calls for an accurate knowledge of the transmitted frequency, the frequency of the crystal used in the receiver, and requires an accurately calibrated test oscillator for the i.f. alignment. The procedure would be considerably simplified if a variable-gap crystal holder were

(Continued on page 78)

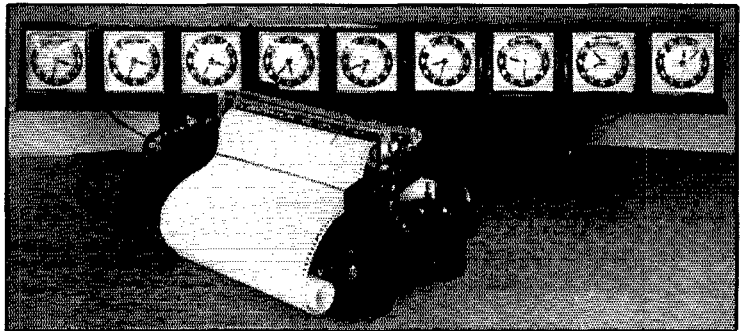

FIG. 5—THE ANALYZING EQUIPMENT USED TO REDUCE THE RECORDINGS OF ULTRA-HIGH-FREQUENCY SIGNALS

The recording is driven through the "console" affair in the foreground by a phonograph motor geared to an appropriate driving roll to give a driving rate 60 or more times that at which the original recording was made. The trace is followed manually and a contact is caused to run across a series of metallic segments cut in accordance with the calibration of the receiver. These segments are in turn connected to relays and eventually to the clocks. A full description is given in the text.

The See-Saw Noise Silencer

Applying an Electronic Gate to Improve Signal-Noise Ratio

By B. S. McCutchen* and D. A. Griffin,** W2AOE

THE subject of noise silencing in radio receivers is a very lively field for discussion and investigation at the present time. The disclosure of the system developed by *QST's* technical editor over a year ago aroused widespread interest in both amateur and commercial circles. The amateur is not alone in a desire to minimize or eliminate one of radio's most annoying handicaps, noisy reception. Hence the present scramble in the laboratories throughout the country to improve existing means of noise suppression and to develop others if possible.

Through an inadvertent "leak," unauthorized publication of an elemental version of this circuit

of rapid negative pulses which are used to bias the injector grid of a 6L7. The output of the i.f. stage is controlled by the amount of this negative voltage. If the voltage is large enough, the tube is cut off completely and a hole of silence takes the place of a pulse of noise.

It has also been found that satisfactory noise silencing can be obtained in a circuit arranged to pass the desired signal voltage without distortion, but which will not pass that portion of a noise pulse which exceeds signal amplitude. For convenience a circuit of this type is known as a "gate." The reason why such gates produce good results is that while signal energy is continuous,

excessive noise voltages are generally of very short duration though frequently of very great amplitude. Hence if noise voltages are reduced to signal amplitude, the ratio of signal energy to noise energy at the output of the gate will be very favorable. This gate action is obtained in the reverse diode circuit which will now be described.

Fig. 1 shows the "see-saw" circuit applied to a conventional superheterodyne receiver. It will be noted that the i.f. stage as well as the audio stage is unchanged. The left-hand pair of diode elements

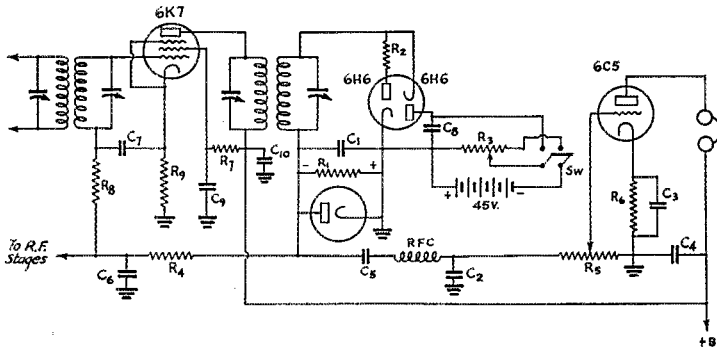

FIG. 1—FUNDAMENTAL CIRCUIT DIAGRAM OF THE "SEE-SAW" SILENCER

R_1 —0.5 megohm.	R_7, R_8 —0.1 megohm.	C_6 —0.05 μ f.
R_2 —1000 ohms.	R_9 —350 ohms.	C_7 —0.01 μ f.
R_3 —25,000 ohms.	RFC—20-mh. choke.	C_8 —0.5 μ f.
R_4 —0.5 megohm.	C_1, C_2 —100 μ f.	C_9, C_{10} —0.1 μ f.
R_5 —0.25 megohm.	C_3, C_4 —0.5 μ f.	
R_6 —1000 ohms.	C_5 —0.01 μ f.	

has occurred in other journals without either proper credit to the inventor, Mr. McCutchen, or a correct analysis of the circuit's operation. The purpose of this article is to describe the operation of the reverse diode "gate," to show its adaptation in a completely automatic circuit, and to outline some broad but necessary requirements in receiver design that must be satisfied if any noise suppressor's operation is to be at its best.

As an introduction, let us review the action of the Lamb silencer.¹ As most amateurs know, a noise amplifier is connected to a full-wave rectifier so that noise pulses are developed in the form

elements of the 6H6 are connected in the usual manner and form the signal detector. The resistance R_2 is connected in series with this diode section to serve a purpose which will be described later. The right-hand pair of diode elements, together with the anode bias battery and potentiometer R_3 , form the noise gate. The pair of diode elements shown below the load resistor, R_1 , is helpful in keeping the gate shut in the presence of very severe noises. The double-pole switch throws the silencer in and out of operation and at the same time prevents the discharge of the anode bias battery through the potentiometer when not in use.

The theory of operation is very simple. The rectifying action of the normal signal diode builds up a negative voltage across resistance R_1 . The

* 89 Olden Lane, Princeton, N. J.

** 10 Maple Place, Irvington, Newark, N. J.

¹ Lamb, "A Noise-Silencing I.F. Circuit for Superhet Receivers," *QST*, February, 1936.

amplitude of this voltage varies with the modulation of the received signal. This constitutes diode detection. Let us assume that the moving arm of potentiometer R_3 is moved all the way to the ground end. The right-hand diode elements, which are reverse-connected, will try to build up a positive potential across R_1 . In this condition our see-saw is in balance except for the effect of R_2 , which for the moment we can forget. One half cycle of i.f. builds up a negative potential and the next half cycle of i.f. drains it off again, the net result being that no audio signal is produced, and the gate is tight shut. Obviously, we receive neither signal nor noise. If we now apply negative bias potential to the anode of the gate diode by moving the arm of the potentiometer away from ground, we can prevent the gate diode from functioning until the amplitude of the received signal exceeds the value of the bias potential. The correct setting is easily determined in practice by simply reducing the bias until the quality of the received signal begins to be hurt, and then increasing the bias very slightly. When operating in this manner the gate diode is kept out of the picture during normal signal

reception, but the instant a noise pulse of amplitude in excess of the signal carrier comes in, the gate diode goes into operation and balances out that portion of the noise pulse which is above carrier level, thus preventing it from being demodulated into an audio pulse.

The purpose of R_2 is to handicap the signal diode slightly, so that when noise pulses bring the gate diode into operation, it will have a little leverage on its end of the see-saw. In practice it has been found that the effect of this resistance is important, as it not only improves the degree of elimination, but also makes the setting of the potentiometer less critical. In most cases a value of 1000 ohms has been found satisfactory, but this depends to some extent on the particular receiver, and it is suggested that a range of values from several hundred to several thousand ohms be tried.

As resistance R_2 handicaps the signal diode, in the presence of very strong noise interference the gate diode will win out, and a positive resultant audio voltage will tend to be built up across the load resistor R_1 . To overcome this condition, the leakage diode is connected as shown across the load resistance. Obviously this will drain off any positive potential.

Successful elimination of noise by the circuits described in this article depends on the truth of the assumption that if the amplitude of interfering noise voltages is "chopped down" to approxi-

mately the amplitude of the received signal voltages, the results will be satisfactory. Believe it or not, this is the truth and it has been demonstrated many times in our laboratory by simultaneous oscillograph and ear tests. The reason back of this is doubtless the fact that the signal is relatively continuous while the noise pulses are each of short duration.

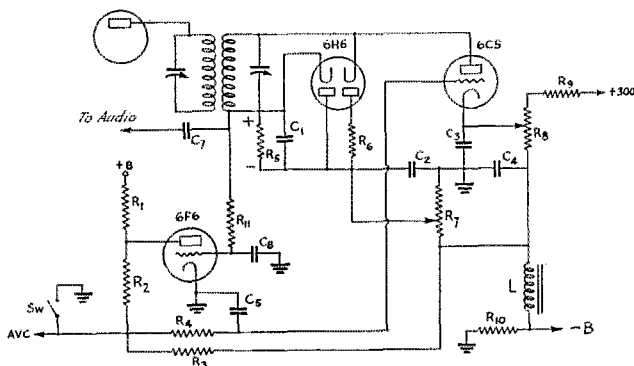

FIG. 2—AUTOMATIC SILENCER CIRCUIT WITH AMPLIFIED AVC

The 6F6 a.v.c. tube is used as a triode, with screen tied to plate.

- | | | |
|---|---------------------|------------------------------|
| C_1 —100 μ fd. | R_1 —25,000 ohms. | R_7 —15,000 ohms. |
| C_2, C_3 —0.5 μ fd. | R_2 —50,000 ohms. | R_8 —25,000 ohms. |
| C_4 —10–20 μ fd., 50-volt electrolytic. | R_3 —15,000 ohms. | R_9 —100,000 ohms. |
| C_5 —0.1 μ fd. | R_4 —0.5 megohm. | R_{10} —See text. |
| C_6, C_7 —0.01 μ fd. | R_5 —1 megohm. | R_{11} —250,000 ohms. |
| | R_6 —1000 ohms. | L —B.C. type filter choke. |

AUTOMATIC NOISE GATE

The automatic circuit shown in Fig. 2 is the final arrangement to be discussed. In the manually-adjusted circuit, if the bias voltage that "delays" the reverse diode is set so that it passes a signal that is producing a rectified voltage of ten volts, for example, across the diode load resistor, the receiver will block if a signal capable of producing 20 volts is tuned in unless the reverse diode is biased off further. If this is not done the reverse diode takes control of the situation, the direction of the a.v.c. voltage is reversed, and the receiver goes dead. This same difficulty occurs with the i.f. type of silencer without automatic control, unless readjustment of the threshold bias of the noise rectifier is made.

Several modifications of the basic circuit have been made to overcome this necessity for constantly adjusting a silencer control in addition to all the other controls found on the modern receiver. The circuit in Fig. 2 seems to provide the best performance of any of them. The first departure from the circuit shown in Fig. 1 is that the signal diode is reversed. That is, the negative half of the incoming signal is rectified. The second is the use of the plate and cathode of a triode tube as a diode with the grid acting as a control of the "diode's" effectiveness. This gate diode is given a small starting delay by the positive potential

(Continued on page 58)

A Fundamental-Reinforced Harmonic-Generating Circuit

Efficient Frequency Multiplication for Four-Band Output
from a 3.5-Mc. Crystal

By John L. Reinartz,* WIQP

WHY it should be customary to use the oscillator tube as a frequency multiplier from the crystal frequency to the second and fourth harmonics and the amplifier tube as only a doubler, I do not know. To prove that the ordinary frequency multiplier can be just as effective as the oscillator when it comes to higher harmonic generation, I tried it out with the circuit combination shown in Fig. 1. The results are such that with a 3.5-Mc. crystal in the oscillator one can obtain enough output from the frequency multiplier at ten meters properly to excite a following ten-meter amplifier.

The circuit is unique in that we make use of the power-output capabilities of the crystal-oscillator circuit not only to excite the grid of the harmonic generator, but also to supply additional power over that obtained from the harmonic generator (up to the value of full load for the crystal-oscillator tube) to keep the harmonic generator going at the higher-order harmonics, such as the 10th, 11th or 12th. The ordinary frequency multiplier gets a "kick" from the exciting source only once every second, third, fourth, etc., cycle of its output frequency, depending upon the order of harmonic being taken from its plate circuit. When the multiplication is great, the oscillations in the plate circuit die down or decay in amplitude between fundamental pulses, thus limiting the output. With the arrangement shown in Fig. 1, additional energy is supplied to the output circuit between the fundamental plate-current pulses caused by the exciting grid voltage, thereby raising the output at the harmonic through the addition of normally-unused energy available from the crystal oscillator. Output can be obtained at even and odd harmonics equally well, and 10 watts output at 10 meters is to be expected using an 807 harmonic generator and an 802 crystal-oscillator.

The circuit arrangement really is quite simple. It is necessary only to excite the grid of the har-

monic generator in the usual way through a coupling condenser, and to bias the grid of the driven tube to twice cutoff as would normally be done in any class "C" stage. The next step then is to couple the plate coil of the crystal oscillator to the plate coil of the harmonic generator. It will be found that proper phasing of the two tuning systems is required; one way it will work and the other way it will not. The amount of coupling is determined by the load that the crystal oscillator can carry, and should be adjusted to make the oscillator tube take normal plate current.

Since with fixed bias the harmonic generator takes no plate current when not excited, it follows that as the crystal oscillator goes to work the plate current of the harmonic generator rises. The current goes through the usual dip when the plate

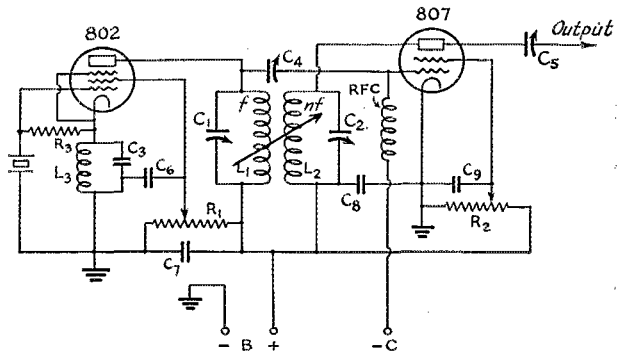

FIG. 1—THE FUNDAMENTAL-REINFORCED HARMONIC GENERATOR CIRCUIT

- C₁—1 μ fd. per meter (80 μ fd. for 3.5 Mc.).
 C₂—1 μ fd. per meter (100 μ fd. max. variable suitable for 3.5 Mc. and higher frequencies).
 C₃—100- μ fd. mica.
 C₄, C₅—50- μ fd. variable.
 C₆, C₇, C₈, C₉—0.01 μ fd.
 R₁, R₂—50,000 ohms, 25-watt, semi-variable. Set slider to give rated screen voltages on tubes used.
 R₃—5000 ohms, wire-wound.
 L₁—26 μ h. for 3.5-Mc. crystal (30 turns No. 18 s.c.c. on 1½-inch form.
 L₂—Adjusted to give resonance with 1 μ fd. per meter on desired harmonics.

tank is tuned to the fundamental frequency or any harmonic. For instance, should the tank circuit of the harmonic generator be capable of tuning continuously through the 8th, 9th, and 10th harmonics of the crystal frequency, a dip will occur in the plate current as the plate tuning

(Continued on page 82)

* 176 Wadsworth St., South Manchester, Conn.

A New Kind of Skyhook—The Ladder Mast

Simply-Constructed and Easily-Climbed Tower

By James Millen,* W1HRX

AT ONE time or another just about everything from a ragtime lattice tower made from furring strip and tobacco lath, to a dural miniature of a broadcast-station vertical radiator, has been used as an amateur antenna sky-hook. Some are extremely ingenious, practical and inexpensive; some stay up seemingly by faith alone; some are inexpensive to build but difficult to raise; some are expensive to build but easy to raise; and so on.

One evening quite a few months ago we had a pleasant visit with W6GWX in his shack at

*61 Sherman St., Malden, Mass.



Pasadena. In fact, it was a very pleasant visit, and as the evening progressed, Mac decided that the problem that had been worrying him for many weeks previously, namely, that of getting another pulley and halyard attached to the top of his home-constructed lattice mast, was really no problem at all! He would just climb right up on the lattice work, as if it were steel instead of redwood—which he promptly proceeded to do without mishap. All of which leads up to the resolution that we made upon examining that same tower in broad daylight the next morning—that if ever we were to be so aristocratic as to have a lattice tower of our own, it would be one that could be climbed without requiring the particular brand of inspiration used by W6GWX.

And so last summer when we built a tower at W1HRX to support a "signal squirter" inspired by observation of the result being had at W5BDB, it was a most rugged affair with a conventional ladder firmly bolted on one side and with a large platform and railing at the top.

But now we have been intrigued by the Quist articles and Ross Hull's admonitions into taking a whirl at "V's." Fortunately, a tree was ideally located at the end of one leg and our big tower at the apex, but just nothing but small birches at the remaining end of the proposed "V." Of course, we could have set an undressed flag pole, a 4 × 4, or something of the sort, and guyed it—but, no indeed, it was just too good an opportunity to try out the construction of an unguyed affair—after the nebulous design that had been slowly taking form in the back of our head ever since that eventful night in Pasadena, and which began to crystallize when we examined the stack of ladders at our local hardware store last summer, while selecting the one to bolt on the side of our main tower.

But why say more—the accompanying illustrations and captions rather succinctly tell the story of our latest attempt at mast construction!

TOP—THE FIRST REQUISITE IS A HOLE ABOUT THE SIZE OF THE ONE SHOWN IN THIS PHOTOGRAPH

The ladders will later be spliced together to make the mast.

CENTER—THE FOUNDATION, READY TO BE FILLED WITH CEMENT

The anchor strips are spiked to a triangular frame to keep them in position during pouring.

BOTTOM—READY TO TAKE THE MAST

The bottoms of the ladders later will be bolted to the anchoring strips.



SPLICING AND PAINTING

Twenty- and ten-foot ladder sections are bolted together with angle-iron strips (the bend in the strips is 120 degrees).



THE BOTTOM SECTION IN PLACE ON THE FOUNDATION

The plumb bob is an essential to keep the mast exactly vertical as its construction goes up.

SOME USEFUL POINTERS

The first step in the erection of the mast is the construction of a suitable base. The hole for the base should be at least three feet deep and three feet square, preferably larger at the bottom than at the top.

Cement economy can be achieved by using quite a few rocks in with the cement. Before pouring the cement and placing the rocks, the steel inserts for attaching the ladder to the base should be put in place. A triangular frame of 2 x 4's was found quite practical for this use. The steel inserts were attached to the ends of each of the 2 x 4's with a spike. The entire assembly was then placed in the hole and carefully leveled. Care must be used in shoveling the concrete into the hole and in throwing in rocks to see that the alignment of the inserts is not disturbed.

For inserts we used standard building irons as stocked by most building supply companies for tying masonry walls to timber frames. They are iron straps approximately 1/4 inch thick, 1 1/2 inches wide and 2 inches long, with a crow-foot end for anchoring in the concrete.

While these supports were quite ample for our particular mast, we feel that on a higher mast it would be well to use much wider strips for this purpose and to have them extend quite a distance farther up each ladder leg than in our case. In an unguyed mast of any appreciable height, there is considerable strain on the corner posts at the position of attachment to the base, and a large overlap between the corner posts and the steel inserts, consequently, is very advisable.

The cement base should be given ample time to harden before starting the erection of the tower; three or four days is not at all too much. If any old iron wire, steel re-enforcing rods or other such material is handy, it is wise to throw a few pieces into the hole while pouring the concrete.

In some sections of the country it is difficult to obtain the shorter length ladder with parallel sides; that is, one in which the top rung is not shorter than the bottom rung. Also, it is sometimes hard, we find upon inquiring at different Boston hardware stores, to get 10- or 15-foot ladders that are exactly the same width as the 20-foot ones. We solved the problem by buying only 20-foot lengths and cutting them into the required sections for staggering the joints. If the mast is to stay in service a long time, it is strongly recommended that heavy plates and bolts be used in the assembly, so that if

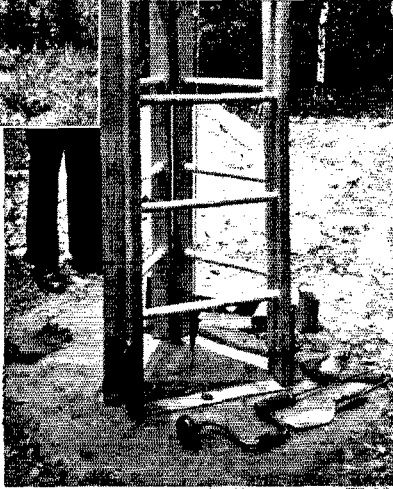

UP WITH ANOTHER SECTION!

The author recommends a linesman's belt for this job, although he doesn't seem to be wearing one.



READY FOR THE ANTENNA

With reasonable loads, this type of mast does not require guying until heights of forty or fifty feet are reached. It's a snap to climb it.

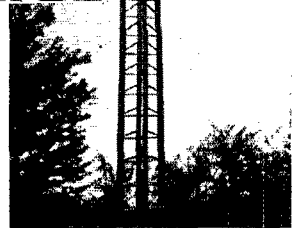

neglected and allowed to rust, it will be many years in reaching a dangerously weak state.

The tower is first completely assembled on the ground, painted, and all parts carefully numbered; then all but the bottom section disassembled. (A convenient time for painting is when the tower has been pre-assembled; then, before dismantling it for erection, the different sections can be numbered on top of the paint. We made the mistake of numbering first, disassembling, painting, and then trying to fit the pieces together when the tower was half in the air!) The bottom section is easily up-ended by two people and bolted in place to the base inserts. If necessary, thin shims can be driven under some of the corner posts to bring the entire unit truly vertical. A plumb bob dropped through the center is the most practical way to determine when the mast is properly lined up. When the lower part is properly lined up and rigidly fastened, then proceed to add one ladder at a time, as you climb spirally up the assembly. Always advance the suspension point of the plumb bob as you add another unit, and carefully adjust its alignment. Incidentally, be sure to use a belt, rope with the right kind of knot, or other means of securing yourself to the tower during this process, so that both hands are free for fastening bolts and hauling up additional ladder sections. Don't, however, indulge in the trick attributed to W6ZH. As his friends know only too well, Herb is a most meticulous sort of fellow, and when, not so long ago, he wanted to try out some large vertical V's for 60-megacycle work, he found he needed another 8-foot or so extension on one of his California telegraph poles (California used in the same sense as in "California kilowatt"). Not having a linesman's belt, he took some sash cord and carefully fastened himself at the top of his pole, then proceeded to spike in place an overlapping piece of 2 by 4 to give the required additional extension. Just about that time, he was suddenly faced with the problem of how to get the several turns of sash cord out from under the 2 by 4. We have heard that someone finally came to his rescue with a knife!

Just how high a ladder mast can safely be carried without guys is a matter on which we hesitate to express a definite opinion. Maximum local wind velocity will, of course, have much to do with the matter. In our case, the original un-guyed mast was limited to thirty feet, plus a three-foot extension to make it suitable for use also as the support for a half-wave vertical radiator at twenty. By the addition of three guys, however, the height may safely be extended a great deal higher. Of course if we want to work on the same narrow factor of safety by which some of our friends seem to have been getting by for quite a few years now, we might suggest much greater heights. Cost? In Boston the ladders come to 25¢ per foot—thus becoming 75¢ per mast foot.

New Beam Power Transmitting Tubes

THE success of the small beam tubes has led to considerable development work on the part of at least one transmitting tube manufacturer in the attempt to produce larger tubes with equally-desirable characteristics. This work has now proceeded to the point where Raytheon is announcing tentative characteristics and data on beam counterparts of the RK-20 and RK-28. The new beam tubes will be known as the RK-47 and RK-48, respectively. A hard glass bulb and larger filament on the smaller tube have made possible increased ratings over the RK-20. These tubes are tetrodes, the suppressor having been replaced by beam-forming plates, although secondary emission from the plate is absent, as in all beam tubes, because of the formation of an electronic suppressor. The lack of a physical suppressor grid of course obviates the possibility of suppressor modulation, but either grid-bias or plate modulation can be used.

THE RK-47

Tentative ratings and characteristics of the RK-47 are as follows:

Filament voltage	10 volts
Filament current	3.25 amp.
Plate voltage, max.	1250 volts
Screen voltage, max.	300 volts
Plate dissipation, max.	50 watts
Screen dissipation, max.	15 watts
D.c. grid current, max.	10 ma.
R.f. grid current, max.	5 amp.
Interelectrode capacities:	
Grid-plate	0.12 μ fd.
Input	13. μ fd.
Output	10. μ fd.

In normal operation as a Class-C amplifier, the grid bias at the maximum plate and screen voltages recommended above should be 70 volts negative. Under these conditions the plate current, power output and efficiency are largely a function of the d.c. grid current. Plate dissipation is practically constant at 50 watts at grid currents from 1 to 10 milliamperes. With 10-ma. grid current, typical operation gives the following data: plate current, 150 ma.; power output, 138 watts; plate dissipation, 50 watts; screen current, 25 ma.; driving power, 1.55 watts. Except for the low driving power, these operating conditions about correspond with those recommended for the 203-A. The filament places the tube definitely in this class, although it should be noted that the maximum recommended plate dissipation is lower.

In external appearance, the RK-47 is like the RK-20. It has the same five-prong base, and base connections are the same except that the beam-forming plates are connected to the suppressor pin. This connection should be grounded.

(Continued on page 90)

An Effective Linear Filter for Harmonics

Suppression of Even and Odd Harmonics with an Inexpensive and Easily-Constructed Transmission Line

By J. N. A. Hawkins,* W6AAR

PRACTICALLY all the odd harmonics, and some of the even harmonics, generated by amateur transmitters fall outside the amateur bands. Therefore to avoid causing interference to other stations and services it is necessary that every amateur station provide means for attenuating the radio-frequency harmonics of the transmitter frequency. The balanced push-pull amplifier helps to reduce the even harmonics, but unfortunately it is a prolific generator of odd integral harmonics. There are several filter circuits and antenna arrangements which will either eliminate the even or the odd harmonics but few

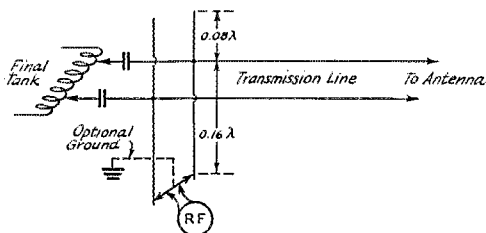

FIG. 1—THE LINEAR FILTER IS CONNECTED ACROSS THE TRANSMISSION LINE, PREFERABLY NEAR THE POINT WHERE THE LINE CONNECTS TO THE TRANSMITTER

The filter will work equally well with tuned or untuned lines.

arrangements will cut out both the even and the odd, and they are complicated and hard to adjust.

The quarter-wave stub arrangement shown in Fig. 1 represents a simple and effective answer to this problem. This filter is tapped on to either the transmission line, antenna or the transmitter output terminals, the latter point being preferable. The line is connected to the stub at a point one-third of the length of the stub away from the open end of the stub. Thus the arrangement consists of an 0.08 wavelength open-end stub in parallel with a 0.16 wavelength closed-end stub. These electrical lengths refer to the fundamental transmitter wavelength. The total length of each side of the filter is a quarter wavelength at the fundamental, so that the filter represents practically an infinite impedance at the fundamental wavelength and has no effect on the desired transmissions. The filter represents a short circuit of only a very few ohms impedance to both the even

and odd harmonics, and thus prevents them from reaching the antenna system. The stub filter can be used across either a tuned or untuned line and has no detuning effect, since it introduces no reactance at the fundamental or any of the integral harmonic frequencies of the transmitter.

The operation of the filter is quite simple. On the second harmonic, for example, the filter acts as a half-wave section, short circuited at a high-voltage point. This short circuit at a high-voltage point prevents the second harmonic voltage from building up and thus reflects back into the transmission line a short circuit of only a few ohms impedance at the second and other even harmonics.

On the third harmonic the stub becomes two filters in parallel. The length of each side of the stub filter becomes three quarter-waves, so that the filter now represents a quarter-wave open-end stub in parallel with a half-wave closed-end stub, both of which offer practically zero imped-

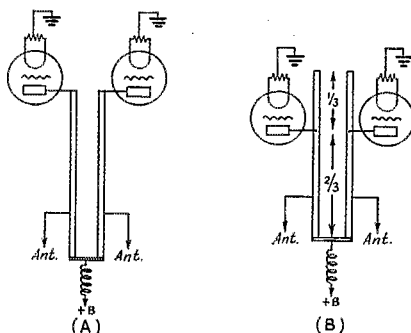

FIG. 2—APPLICATION OF THE HARMONIC-SUPPRESSION PRINCIPLE TO A LINEAR OSCILLATOR OR AMPLIFIER

(A) Conventional method of coupling "pipes" to the plates of the tubes in a u.h.f. push-pull oscillator; (B) method of coupling to eliminate harmonics.

ance (a short circuit across the line) to the third and higher odd harmonics.

The stub can be practically any size wire and any convenient spacing can be used. The length of the stub will approximate 0.24 wavelengths but will vary slightly with the wire size and spacing. Thus, the shorting bar at the closed end should be

* 2807 8th Avenue, Los Angeles, Calif.

(Continued on page 62)

Candid Shots at the 1937 Board Meeting



Paul Segal, general counsel and unofficial photographer-extraordinary to the Board, grabbed these shots during the May session of the A.R.R.L. Board. Names if you want them, down the columns, left-hand one first: McCargar behind the pipe, Mathews listening. Reid smiles as Gibbons expounds. Handy lays something before Vice-President Bailey. Matty telling 'em, Martin and Caveness in background. Next column: Blalack in a study, Jabs amiable. Dinnertime lull with Budlong, Bailey, Reid, Hebert, Arledge. Cross-table luncheon talk, Stockman, Jabs, Ken Hill, Adams. Early workers, Stockman and Groves

What the League Is Doing

League Activities, Washington Notes, Board Actions—For Your Information

League Notes

A.R.R.L. membership cards (instead of certificates) are now available to members who prefer them and so specify when paying their dues. However, extra cards are not available for those who already have certificates—not until their dues are again payable. . . . President Woodruff has named Directors Martin, Norwine and Blalack to constitute the Board's committee to sponsor an increase in League membership, Mr. Martin being the chairman. . . . The Constitution and By-Laws of the League have been reprinted to show changes up to the end of the last Board meeting. Interested members may obtain a copy upon request. . . . The Communications Manager is busy these days examining sites for the new W1AW and making plans for the new station building, upon which work will be hurried during the summer. The Secretary is similarly occupied with plans for rearranging the headquarters offices as the League takes over the entire building in which it has been located. Office quarters have been cramped for a year, and the new arrangement will permit many pending plans to go ahead. By autumn we should have a "plant" of which anyone could be proud.

F.C.C. Notes

The Federal Communications Commission now has before it the request of the A.R.R.L. Board for a change in the 28-Mc. 'phone assignment, its proposals concerning emergency communication by amateurs, and its suggestion about a change in licensing policies to require a year of c.w. experience before 'phone operation. The 28-Mc. matter probably will be enacted soon; but up to the moment of writing these lines no information has become available as to the Commission's attitude towards the Board's other proposals. . . . Lieutenant Jett, active administrator of amateur radio in his office of assistant engineer in charge of the Telegraph Division, has been out of the country, attending the C.C.I.R. meeting at Bucarest. . . . To our immense disappointment, Dr. Irvin Stewart, vice-chairman of the F.C.C. and chairman of its Telegraph Division, has announced that he is not a candidate for reappointment to the Commission when his term expires on June 30th. The Commission's loss is here our loss, for Dr. Stewart has been a thoroughly competent and intellectually-honest administrator and in our opinion one of the most valuable men who have ever served the Commission. . . . B.C.L. QRM complaints are slightly decreasing in number. . . .

In Rule 411, the words "90 days" have been changed to read "3 months." . . . Through the efforts of the League, the half-dozen W7 stations cited for operation during the Oregon blizzard, at which time the F.C.C. had a stop order on normal amateur work, have been given clean bills of health on all the major citations. However, some of these stations were cited for insufficient filtering, A-2 emission and similar infractions regarding the quality of signals, and they will have to answer on these. . . . The Commission is examining the possibilities of holding amateur examinations in a number of additional cities during the next fiscal year—points which the Inspectors have to visit in any event for the purpose of inspecting other classes of stations. We shall have word soon.

Habana

The League has asked the government of the United States to propose the addition, to the agenda for the Pan-American conference to be held at Habana in November, of the question of permitting amateurs of all of the American countries to interchange third-party traffic of a nature that would not normally go by any paid service. The recent successful Buenos Aires peace conference emphasizes the community of good feeling existing amongst the twenty-odd nations of the Americas. The League feels that such a proposal emphasizes the common destiny of the people of the Americas and is in keeping with the aspirations of the President. . . . As was reported last month, our Board has expressed itself on a proposal on the Habana agenda that the Latin-American countries be permitted to use telephony between 7000 and 7100 kc. Our Board is opposed to any 'phone operation in this band, but recognizes the right of the countries to the south of us to permit telephony in this band if they so insist, and feels that, if it is to be permitted, it is highly desirable to confine it to a portion of the band, instead of permitting it to appear all through the band—as many gnashing teeth now testify.

Financial Statement

The League has enjoyed the largest quarterly gain in its history during the first quarter of this year, with a net of over \$20,000 before disbursements against appropriations. The first quarter is generally the best of the year, to be followed by two lean ones. We should also point out that appropriations by the Board now take on very sizable proportions, and the funds to make them

possible are provided by these initial gains from operations. By order of the Board, the quarterly statement is here reproduced for the information of members.

STATEMENT OF REVENUES AND EXPENSES,
EXCLUSIVE OF EXPENDITURES CHARGED
TO APPROPRIATIONS, FOR THE THREE
MONTHS ENDED MARCH 31, 1937

REVENUES	
Membership dues	\$15,572.40
Advertising sales, <i>QST</i>	24,637.12
Advertising sales, Handbook	10,996.95
Advertising sales, booklets	525.00
Newsdealer sales, <i>QST</i>	12,061.37
Handbook sales	15,272.33
Booklet sales	3,979.09
Calculator sales	538.41
Membership supplies sales	3,554.91
Interest earned	640.75
Cash discounts received	416.43
Bad debts recovered	59.86
	\$88,254.62
<i>Deduct:</i>	
Returns and allowances	\$ 3,505.47
Collection and exchange	21.86
Cash discounts allowed	529.92
	\$ 4,057.25
Less decrease in provision for newsdealer returns of <i>QST</i>	16.58
	4,040.67
Net Revenues	\$84,213.95

EXPENSES	
Publication expenses, <i>QST</i>	\$17,214.65
Publication expenses, Handbook	10,050.88
Publication expenses, booklets	1,345.12
Publication expenses, calculators	266.59
Membership supplies expenses	1,939.62
Salaries	23,165.64
<i>QST</i> forwarding expenses	889.68
Office supplies and printing	1,261.03
Postage	2,140.46
Telephone and telegraph	799.76
General expenses	993.37
General Counsel expenses	260.90
Insurance	449.09
Rent, light and heat	846.59
Travel expenses, business	979.62
Travel expenses, contact	714.20
Provision for depreciation of furniture and equipment	312.80
Communications Dept. field expenses	132.29
Headquarters station expenses	13.54
Total Expenses	63,675.83
Net Gain before Expenditures against Appropriations	\$20,538.12

Age-Limit Bills The House so far has done nothing with a bill which would require a minimum age of twenty-one years for the holder of any radio operator license. Although never intended to apply to amateurs, the text of the bill unfortunately does. The League has made suitable representations, and is pleased to report that the F.C.C. itself has recommended that an exception be made in the case of ama-

teurs. At this writing a somewhat similar bill has just been introduced in the Senate, specifying a minimum limit of twenty-one years but authorizing the Commission to relax this requirement in the case of amateurs. This is better, but not quite good enough. We see no reason why age should be a factor in the case of amateurs who are otherwise qualified, and we much prefer to be left in our present status with no mention at all of an age limit for amateurs.

C.C.I.R. Notes Word from Messrs. Lamb and Stadler during the early days of the C.C.I.R. meeting at Bucarest is that everything is going smoothly enough, with no complications involving amateur radio. We had hoped that during this conference in Bucarest we might have a "special arrangement" permitting the exchange of third-party messages on behalf of the numerous Americans attending the conference, but the Roumanian government regrets its inability to relax its traditional restrictions. . . . En route to Bucarest, Messrs. Lamb and Stadler were the guests of the *D.A.S.D.* in Berlin, where they were most hospitably received. Returning, they are being similarly received in Paris by the *Reseau des Émetteurs Français*, and in London by the Radio Society of Great Britain. Thanks, OM's—FB!

Cairo Proposals The Book of Proposals for the Cairo conference arrived in this country in early April and is in process of official translation. Meanwhile we have made our own abstract of the proposals affecting amateur radio and they are to be found hereunder for the information of members. Reference is also to be made to an item on this same subject in this department last month. It will be noted that good old Europe hands us a stiff dose of its usual medicine, accompanied, as usual, by at least one large pill from Japan. France, however, proposes widening our 7-Mc. band to 7500. *Vive la France!* Credit for this goes to the R.E.F., the only amateur society in the world that succeeded in inducing its government to propose widening!

Nos. 19 & 20, United States:
In Article 1, definitions, the United States proposes a new definition for the fixed service, "A service carrying on radio communications between specified fixed points," and gives as one of her reasons the desirability of avoiding a definition that would also cover amateurs. She then proposes the insertion of the following new definition: "Amateur service: the service of experimentation, self-training and intercommunication carried on by amateur stations." She gives as her reason the desirability of making it clear that the definition of the fixed service does not include the amateur service.

No. 44, Australia:
In the Madrid allocation, the frequencies 30 to 56 Mc. are not assigned, those from 56 to 60 Mc. assigned jointly to amateurs and experiments. Australia now proposes a subdivision of these frequencies. Her proposal would maintain
(Continued on page 50)

A Four-Band Portable or Mobile Transmitter

A Compact Crystal-Controlled Unit for 56, 28, 14 and 7 Mc.

By Frank Jacobs,* W2BSL-W2XHV

FIVE-METER mobile activity has been on the increase each successive year since its introduction several years ago. The squealing transceiver provided a wedge into the region of the ultra-high frequencies, but the time has arrived for the introduction of more stable equipment following the lines of good practice on other bands.

The transmitter to be described in this article not only has real output and frequency stability on 5-meter 'phone, but may be used on 10-meter 'phone as well. At this writing, word has been received that amateur contacts have been made across the continent from a mobile station. One need not lack communication, no matter where he may be; even 40- and 20-meter c.w., using a portable antenna, is now open to the ham using a transmitter of this type, although the regulations do not permit mobile operation on these two bands.

The experienced amateur who has followed the popularity trend from the 10 crystal oscillator to the 47 and then to the 6A6 oscillator-doubler will not be surprised to learn that the 6L6 beam tube oscillator is rapidly coming to the fore. The fears expressed for the older types have disappeared, as will those expressed for the 6L6 power oscillator by reason of careless usage.

It has been shown in several recent

* Radio Transceiver Labs., Richmond Hill, N. Y.

articles¹ that high-power crystal oscillators do not necessarily entail fractured crystals. That crystals

¹ J. M. Wolfskill, "Operating Notes on Power Crystal Oscillators," *QST*, Feb. 1937; J. J. Lamb, "Practical Survey of Crystal Oscillator Circuits," *QST*, April, 1937.

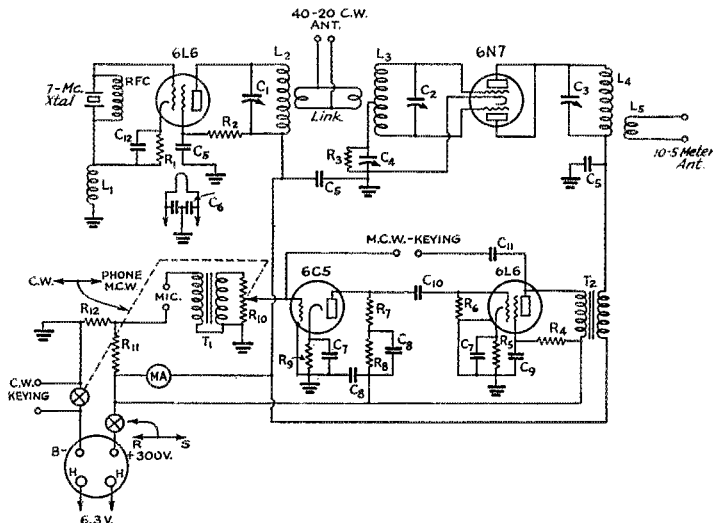
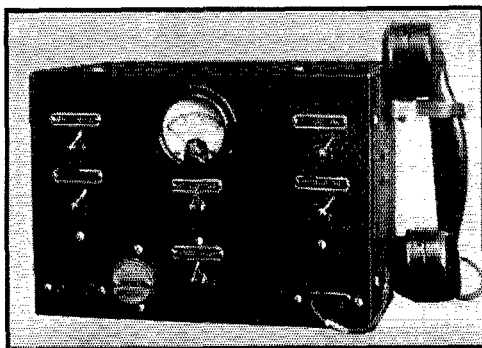

FIG. 1—CIRCUIT OF THE MOBILE TRANSMITTER

- | | |
|--|--|
| <p>L₁—10 turns, No. 12 enameled, outside diameter 3/4 inch, spaced with No. 12 to occupy 1 1/8 inches. Mounted inside a Bud 1 1/4-inch dia. plug-in form.</p> <p>L₂—16 turns, No. 20 enameled, spaced to occupy 1 1/16 inches, on Bud 1 1/4-inch dia. plug-in form.</p> <p>L₃—14 Mc.: 24 turns No. 20 enameled on 1-inch dia. form, close-wound, center-tapped.</p> <p>28 Mc.: 12 turns No. 14 enameled wire, center-tapped, outside diameter 3/4 inch; length 1 inch. Leave 1/4-inch space at center of coils for two link turns.</p> <p>L₄—28 Mc.: 12 turns No. 12 enameled, outside dia. 3/4 inch, spaced with No. 14 to occupy 1 1/2 inches.</p> | <p>56 Mc.: 4 turns No. 12 enameled, outside diameter 3/4 inch, spaced to occupy 3/4 inch.</p> <p>L₅—2 or more turns No. 12, diameter 3/4 inch, spaced to match antenna feeders.</p> <p>Tiny plugs and Mica-lex-insulated jacks used for L₃ and L₄.</p> <p>C₁—50 μfd. (Cardwell Trim-Air).</p> <p>C₂—25 μfd. (Cardwell Trim-Air).</p> <p>C₃—15 μfd. (Cardwell Trim-Air).</p> <p>C₄—50-μfd. isolantite padder (Solar). See text.</p> <p>C₅—0.004-μfd. mica.</p> <p>C₆—Dual 0.01 μfd. (Aerovox 284).</p> <p>C₇—10-μfd. 35-volt (Solar).</p> <p>C₈—1-μfd. 500-volt (Solar).</p> <p>C₉—0.1 μfd. (Aerovox 484).</p> <p>C₁₀—0.05 μfd. (Aerovox 484).</p> <p>C₁₁—0.01 μfd. (Aerovox 684).</p> <p>C₁₂—250-μfd. mica.</p> <p>R₁—500-ohm, 10-watt (Ohmite Brown Devil).</p> <p>R₂—20,000-ohm, 2-watt carbon.</p> <p>R₃—5000-ohm, 1-watt carbon.</p> <p>R₄—25,000-ohm, 1-watt carbon.</p> <p>R₅—350-ohm, 1-watt carbon.</p> <p>R₆—500,000-ohm, 1/2-watt carbon.</p> <p>R₇—50,000-ohm, 1/2-watt carbon.</p> <p>R₈—10,000-ohm, 1/2-watt carbon.</p> <p>R₉—2,500-ohm, 1-watt carbon.</p> <p>R₁₀—500,000-ohm volume control and switch (Centralab).</p> <p>R₁₁—25,000-ohm, 10-watt (Ohmite Brown Devil).</p> <p>R₁₂—250-ohm, 1/2-watt carbon.</p> <p>T₁—Shielded microphone transformer (UTC CS-103).</p> <p>T₂—Shielded output transformer, 4500 ohms input, 5000 ohms output (UTC).</p> |
|--|--|

are easily broken by experimenters who do not give proper consideration to the characteristics of the tubes and the circuit constants is well known. The reader is referred to these other sources for the factors involved in successful and sane crystal operation. This article is concerned only with the practical performance of modern types chosen to save expense and space.

The heart of this compact four-band transmitter is the 6L6 crystal circuit, which employs a 40-meter crystal. By the use of only two coils and



PANEL VIEW OF THE FOUR-BAND PORTABLE-MOBILE TRANSMITTER

The crystal plugs in on the front panel.

one tuning condenser, outputs may be had on 40, 20 and 10 meters. The crystal current is low compared with conventional tuned-cathode Tri-tets; whereas the latter may run from 50 to 100 ma. of r.f. crystal current this oscillator does not approach 25 per cent of that value when used straight through or as a doubler. When quadrupling to 10 meters the crystal current is highest.

It is a simple and inexpensive matter to check the crystal current and at the same time protect quartz with a fuse. The 6.3-volt No. 40 Mazda pilot lamps are rated at 105 ma. at maximum brilliance, and 50 ma. of crystal current will cause just a barely-visible glow. The oscillator used in the four-band transmitter has a crystal current which just lights the bulb when quadrupling to 10 meters, while 20- and 40-meter operation give no visible indications, and may be assumed to be well below 50 milliamperes. The plate voltage is 325 and the automatic screen voltage 275 volts. Higher voltages may be employed safely if the lamp "fuse" is closely observed.

The schematic circuit of Fig. 1 indicates how the output of the crystal tube is utilized for c.w., or for the external excitation of other tubes, on 40 and 20 meters. A second tube is employed as a doubler-amplifier for 10 and 5 meters, the familiar push-push circuit employed using a 6N7

twin-triode.² Regeneration is employed here and the resultant output greatly exceeds the driving input, in spite of the doubler action. Proper shielding and wiring is important in order not to introduce self oscillation. The by-pass capacity C_4 is important in determining the degree of regeneration. Values over 100 $\mu\text{fd.}$ may cause oscillation, as has been previously described.² The writer tried several values from 30 $\mu\text{fd.}$ upward and found that the layout used required about 40 $\mu\text{fd.}$ Oscillation took place at about 45 $\mu\text{fd.}$ It is well not to approach the threshold of oscillation too closely, and for that reason a variable trimmer is employed and is backed down to a safe value consistent with high output power. If the trimmer is not large enough a small fixed capacity may be shunted across it.

An audio amplifier consisting of a 6C5 resistance-coupled stage feeding a 6L6 is employed for voice or tone modulation of the carrier. A gain control permits adjustment for various input levels. Average single-button microphones require a gain advancement of about one-third of the total scale for 100 per cent modulation. An interesting feature of the integral i.e.w. is the fact that the tone may be varied over a wide range to suit the operator, by manipulation of the same control. Phone and i.c.w. are employed on 5 and 10 meters only; c.w. on 20 and 40 meters.

The reader may assume that a transmitter employing only two r.f. tubes for four-band output with a single crystal would be difficult to tune and operate. Furthermore, he might believe

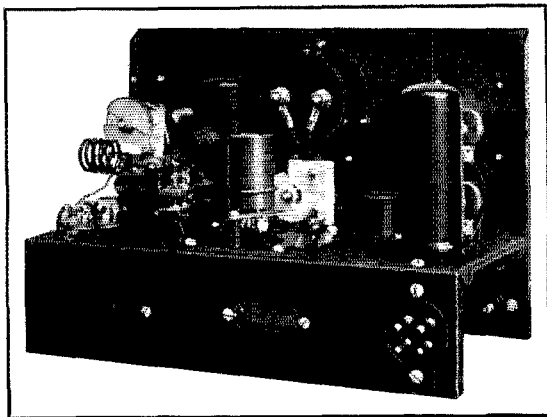

A REAR VIEW OF THE TRANSMITTER

The 6N7 is mounted underneath the chassis. This photograph was taken during the early experimental work and does not show the 6C5, which was later mounted on the chassis alongside the 6L6 modulator.

that a multiplicity of coils are required. Neither assumption is true.

The crystal oscillator is tuned to 40 meters by

(Continued on page 64)

² 1937 A.R.R.L. Handbook, p. 273.

How Would You Do It?

Designs for Convenient and Easily-Constructed Operating Tables: Announcing the Seventh Problem

IN Problem No. 5, our Hero was in need of plans for an operating table which would accommodate the usual collection of stationery, books, tools and the usual odds and ends, which often clutter up an ordinary table, as well as the receiver, monitor, etc. At the same time, the design had to be sufficiently simple to permit construction with ordinary hand tools. Since O.H. is not a cabinetmaker by trade, he wished to avoid making close-fitting or complicated joints.

Of the multitude of suggestions received in reply to his request, we have chosen the two designs which follow.

— . . . —

First Prize

Suggested Design for a Radio Table

By Thomas O. Crow, W6HGW¹

THIS bench or table may be built by anyone possessing a fair degree of mechanical skill and with a minimum number of carpenter's tools. There are no complicated joints to make and, for the most part, it is simply a matter of cutting the material and nailing it together. A bench similar to the one described has been in use at W6HGW

One is to buy a panel of $\frac{3}{4}$ -inch five-ply Douglas fir veneer, which may be obtained in widths of four feet and any desired length. It has a perfectly smooth surface and makes an ideal table top. The other alternative is to fasten several fairly smooth boards together with cleats and cover the top with a sheet of one-eighth inch Masonite or Pressed Wood, which is sold under various trade names in different localities. The "tempered" variety is preferable, as it has a hard, almost varnish-like surface. It is fastened to the board top with small brass escutcheon pins, by drilling small holes in the Masonite along the edges about 6 inches apart and driving the heads of the pins down flush with the surface of the Masonite. A neat-looking edge may be secured by planing the edges of the boards and the Masonite after the Masonite is fastened in place. A more finished job is made by using some of the brass binding that is used for covering the seams of linoleum and tacking it along the edges of the table.

The top must be supported, which can be done in two ways. If the landlord or the XYL will permit, the better plan is to build two brackets of 2- × 3-inch material, as shown in the sketch,

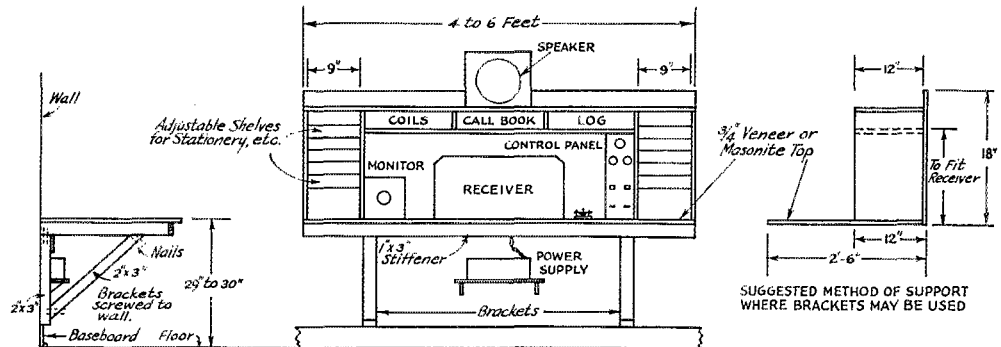

FIG. 1

for two years and has proved to be very satisfactory. It is shown in the diagram of Fig. 1.

The most important, and at the same time the most difficult, part of a table to construct is the top. It must be smooth to permit writing with ease. At the same time it must be perfectly rigid. For one who is not equipped or inclined to go to the labor of joining and gluing several boards together to form a top there are two solutions.

¹ 4376 Arrowhead Blvd., San Bernardino, Calif.

and fasten them to the wall by means of large wood screws driven through the plaster and into the studding of the wall. In this way there are no table legs to get in the way of one's feet. The studding in the walls may be located by tapping along the wall with a hammer until it feels solid. The studding is generally on 16-inch centers, hence, having located one stud, it is an easy matter to locate the others by a little measuring.

If the bracket form of construction is used, it

will be necessary to stiffen the top between the brackets. This may be done by nailing a 1-inch by 3-inch piece across the front end of the brackets, and a 1" × 6" piece across the front of the vertical legs of the brackets, notching it so as to clear the horizontal bracket members.

If the mention of fastening the table to the wall brings forth the storm clouds, it would be best to employ the more orthodox method of

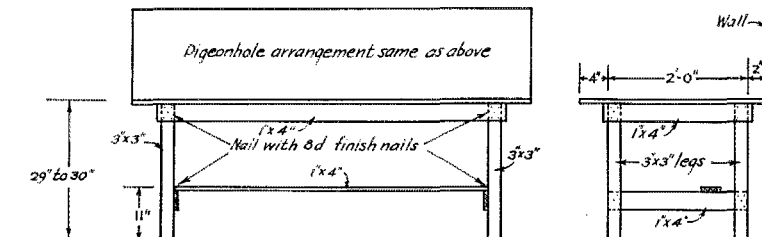

SUGGESTED METHOD OF SUPPORT WHERE BRACKETS CANNOT BE USED FOR SUPPORT

FIG. 2

using four legs, as shown in Fig. 2. These may be made of 3" × 3" material, fastened at the top with 1" × 4" pieces, and with a cross piece at each end about eight inches from the floor and a longitudinal brace between them, as shown by the sketches.

The table should be about 30 inches wide, and from 4 to 6 feet long, depending upon one's individual ideas. For best operating convenience the top should be from 29 to 30 inches above the floor.

By buying all lumber surfaced on four sides, the labor of building this table is reduced to a great extent. The greater part of the work will be

simply cutting the material and fastening it together. A good grade of pine looks well and, when sandpapered and finished with dark mahogany stain, it will make a table of which no one need be ashamed.

Now having the table, comes the question of arranging for log books, stationery, spare coils, a monitor, control panel and other miscellaneous gear besides the receiver. One's personal likes and

dislikes enter into this to such an extent that it is hard to plan any definite setup. However, the arrangement shown has proved satisfactory, and it is offered as a suggestion. The back panel may be the 18-inch piece left over after having cut the four-foot panel down to 30 inches. The rest of the shelves and

pigeonholes may be made of 1" × 12" pine, which may be bought at the lumber yard surfaced on four sides, ready to be cut and nailed into place. All joints should be nailed with eight-penny finish nails.

The receiver occupies the center of large space, with the key and control panel on the right and the monitor on the left. The power supply rests on a small shelf under the table out of the way. The long spaces above the receiver are for spare coils, log book and call book. The speaker sits on the top shelf along with an electric clock. The small shelf on each side will receive stationery, pencils, magazines and books. These shelves may be made of wood, or better, by making saw cuts in the side pieces about an inch apart and 1/8-inch deep, to receive pieces of 20 gauge galvanized iron which are slid into them to make shelves that are easily adjustable, to suit one's convenience.

Second Prize

Rack Style Operating Position

By Winston V. Bradbury, W5CIQ²

MY solution to Problem No. 5 is shown in the drawings of Fig. 3. The use of the space is as follows:

- A—loud speaker.
- B—antenna tuner.
- C—small monitor.
- D—final amplifier.
- E—Exciter stages (two or three).
- F—power supplies (receiver supply included).
- G—receiver.
- H—log, call book, writing paper, etc.

(Continued on page 86)

² 1825 Baronne St., New Orleans, La.

Problem No. 7

OUR pal has been bitten by the mobile bug and is all set to fix a 28- and 56-Mc. rig in his automobile. The car has one of these all-metal tops and no amount of argument with the ex-YL has softened her demand that no holes be made in the tinware. His problem is to find a complete plan for the installation of an antenna and feeder system. The arrangement must be capable of operation on both 28 and 56 Mc., but it is not essential that the change from one band to the other be made from inside the car. On the other hand, the antenna must serve for both transmission and reception and some appropriate method of changing over the feeders must be provided. If any brackets or fitments are called for, our hero will need complete drawings and details.

56 Mc. Shoots the Works Again

The Third Annual May Opening Reported

FOR the third consecutive year, the five-meter band put on a grand May-time show. This business of the band opening up for long-distance work in May is now getting to be a well-established habit. It must surely be a phenomenon of definite interest and importance in scientific circles. Enough hams are on the job enough of the time to suggest that the May opening, while not necessarily the only one, is at least the major one. Just why this should be so is a question very much in need of an answer.

The only really unfortunate thing about this year's 56-Mc. orgy is that while a great many contacts are believed to have occurred, only four individuals considered the work important enough to be reported. This, of course, is a perfectly punk state of affairs. For many years we have been trying to get a thorough understanding of ultra-high-frequency behavior and because of our numbers, if for no other reason, we have been able to do things that would be impossible or at least improbable in commercially-sponsored experiment. But the work itself is of precious little importance until it is reported and included in the record. Thousand-mile contacts on 56 Mc. are more common now than they were a few years ago but they are still of tremendous significance. We hams are simply falling down on the job if we fail to record every single instance of long-distance u.h.f. working. We at Headquarters try to track down every rumor in the best way we can but we are licked without reports from participants.

Our best report this time comes from Rev. Hollis M. French, W1JLK. He heard and was heard by W9ZEQ during the late evening of May 14. On May 15 shortly after noon, he heard W9UA, W9CLH and, please note, G5BY. Also he had a 12-minute QSO with W8QAR of Dayton, Ohio. During the same period, W1JLK's signals were copied by two short-wave listeners, one in Indianapolis and one in Cincinnati.

The longest DX was reported by Whit. Griffith, W5CSU, operating at M.I.T. in Cambridge, Mass. W5CSU-1 rang the bell by maintaining contact for one hour during the late evening of May 14 with W9URO at Watertown, S. Dakota. It seems that the "9" was hearing several Boston stations, other Boston stations also hearing him.

Kenneth A. Bishop, W1EWD, reports working W8RLS in Cincinnati at 11:30 p.m. E.S.T. on May 15 and hearing W8QVB, W9CLH, W9UAQ and W9RBK (the latter call a bit doubtful).

The fourth report is from Owen Shepherd, Jr., W1IJ who, in spite of being on the band most of the time and in close contact with W1JLK, failed

to hear more than a brief slice of one unidentified DX station. W1IJ was using an eight-element directive array pointed west and both transmitter and receiver were in completely satisfactory condition. Whether his location—30 miles east of W1JLK—explains the phenomenon or whether it is the result of an unfavorable angle of radiation from his antenna in the vertical plane is a question well worth looking into. At any rate, his report of negative result is really of just as much interest as the others.

Our congratulations to those who had a hand in this work; our sincere thanks to the four gentlemen who turned in reports; an earnest plea for complete reports of all long-distance u.h.f. work done in the future.

—R. A. H.

—

Just as we go to press a fifth report arrives from W9RBK at Newport, Ky. W9RBK tells of hearing W1KBM at 1:50 p.m. on May 12th and working W1IWR at 11 a.m. on May 15th.

—EDITOR



DIXIE JONES' OWL JUICE

I DON'T see no sense in all this palaver in the Handbook about how embryo hams should oughto study up and go git a license and a ham call of thair own. They're doin' ok as it is. Just pick one outa the book and go to it. Some of 'em's gittin' nice dx for me. The latest, outsidea what I got already, is a card from a German gentleman in Muenchen and another'n from a Irish gentleman in Belfast who are "psed to QSO" which is news to me. I wisht these call thieves would hurry up and git Japan and South Africa for me. A bootleg WAC certif oughta be sumpn special.

—W4IR of the "Dixie Squinch Owl!"

Correction

In Fig. 2 on page 54, June QST, the negative return between transmitter and power supply of the line-powered beam crystal oscillator was omitted. A connection should be made between the left-hand end of R_3 and the lower end of R_2 in order to apply plate voltage to the oscillator.

Incidentally, we hope nobody was confused by that type "2575" tube in the same diagram! The draftsman left off the bottom of the Z.

Note on Reduction of Distortion and Noise with Inverse Feedback

A FEW of our readers have disagreed with some of the conclusions reached, with respect to optimum inverse feedback conditions for reduction of distortion and hum, in the article describing the construction of a speech-amplifier-modulator unit in April *QST*.¹ Since the criticisms are all of the same nature, we have selected for publication a letter from J. R. Davey, 419 West 119th Street, New York, which gives a rather complete explanation of the operation of the inverse feedback circuit in this respect:

"The section of the article headed 'Curing Distortion and Noise' contains several statements

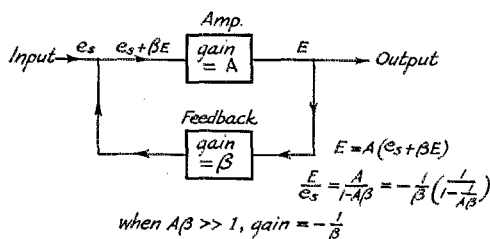

FIG. 1

which I believe to be incorrect. The author begins this section by showing how a 5-volt third harmonic in the 20-volt fundamental output of the amplifier used as an example is eliminated by using a feedback ratio of 1:10. A feedback ratio of 1:10 and a stage gain of 10 would actually cut the distortion and noise introduced in the stage to one-half its original value, and not eliminate it completely.

"The author also applies the same reasoning to the hum elimination problem, reaching the general conclusion that the feedback ratio should be the reciprocal of the gain of the stage. Here again this actually gives a reduction of 50 per cent in noise, distortion and the effective gain of the stage. The statement that if this ratio is exceeded overcompensation would result, and that the distortion would increase, is quite incorrect. As the negative feedback is increased, the noise, distortion, and effective gain all continue to decrease. To get complete cancellation of the noise and distortion would require infinite negative feedback and consequently zero gain. The error in the reasoning is that it neglects the fact that as soon as the noise or distortion is cancelled out in the output by some means, there

is no longer any signal component to feed back and continue the cancellation.

"There also appears to be an inconsistency in that there is first mentioned the possibility of overcompensation and then later that the theoretical ratio of gain of stage is a minimum value and that larger amounts may be used. The actual feedback ratio used in designing an amplifier depends on how much gain it is economical to lose, how much feedback can be used without excessive positive feedback and oscillation at the extremes of the frequency range, and the amount of noise, distortion, or potential supply variations which are being compensated for. There is a feedback ratio in each case beyond which there is no point in going, either because of loss of gain, phase difficulties, or because a closer approach to the desired response characteristic would not be warranted.

"The usual type of nomenclature used in feedback amplifiers is given in Fig. 1. It is to be found in numerous publications treating the subject.

"The reduction of gain caused by the feedback is $\frac{1}{1 - A\beta}$.² This is also the reduction in noise and

distortion produced in the stage.³ The characteristic with feedback approaches that of the feedback or β circuit. When, as in this article, $\beta = -\frac{1}{A}$,

the factor $\frac{1}{1 - A\beta}$ becomes $\frac{1}{2}$.

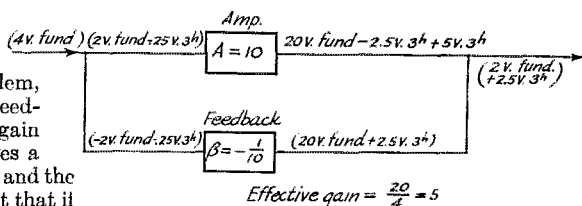

FIG. 2

² When the feedback is negative, as is the case here, β is negative.—Error.

³ The amount of distortion fed back to the grid circuit is equal to β times the resultant distortion in the plate circuit; i.e., the distortion remaining in the output with feedback present. The resultant distortion is the algebraic sum of the original distortion without feedback and the amplified feedback distortion. Letting D = resultant distortion with feedback and d = original distortion without feedback,

$$D = d + A\beta d$$

$$\text{Solving this for } D, \quad D = \frac{d}{1 - A\beta}$$

See Terman, "Feedback Amplifier Design," *Electronics*, January, 1937.—EDITOR.

¹ Carter, "Inverse Feedback Applied to the Speech Amplifier for the Amateur Phone Transmitter," *QST*, April, 1937.

The above factor is demonstrated below in obtaining the table given on page 47, April *QST*:

Freq.	Gain, no feedback (A)	Gain with feedback ratio of $\left(\frac{-1}{5}\right)$
50	$5 \frac{A}{1-A\beta} = \frac{5}{1 - \left(5 \cdot -\frac{1}{5}\right)} = \frac{5}{2} = 2.50$	
1000	$10 \frac{A}{1-A\beta} = \frac{10}{1 - \left(10 \cdot -\frac{1}{5}\right)} = \frac{10}{3} = 3.33$	
10,000	$8 \frac{A}{1-A\beta} = \frac{8}{1 - \left(8 \cdot -\frac{1}{5}\right)} = \frac{8}{1.6} = 3.08$	

"The actual case of the author's distortion example is shown in Fig. 2. The 5-volt third harmonic produced in the amplifier is reduced one-half, to 2.5 volts, but not eliminated. If $A\beta$ should be made as high as 15 to 20, then much more reduction of distortion $\left(\frac{1}{16}$ and $\frac{1}{21}\right)$ would be obtained. I have no doubt that the amplifier as described works very well, but there appears to be no foundation for the desirable feedback ratio of

$\frac{1}{\text{gain of stage}}$."

Improving DX

A Plan for Internationally Subdividing the Long-Distance Bands

IN THE course of a discussion at the last meeting of the Board of Directors on the possibilities of a "planned use" of amateur frequencies, the Board instructed that there be published in *QST* the substance of a proposal now under study in the International Amateur Radio Union. The proposal was made by the *Reseau des Emetteurs Francais*, the French member-society of the I.A.R.U. It was the Board's desire to bring this proposal to all of the members of the League, that amateurs may judge for themselves what potentialities for improvement reside in such a plan, and what sacrifices they would be called upon to make to secure its benefits.

Briefly, the R.E.F. proposes that we all contract amongst ourselves to confine our operations in the 7-Mc. and 14-Mc. bands to certain portions of those bands, in each continent, keeping out of the other portions. In these other portions we would then find the amateurs of other continents free of interference from our own fellows. It is an idea that has often been discussed but on which no action has ever been taken. The present plan

(Continued on page 84)

W3FAR Wins 28-Mc. Contest

THE 1936 A.R.R.L. 28-Mc. Contest winner is Mr. John J. Michaels, W3FAR, of North Wales, Pa. The power input at his station was kept under 50 watts during the entire 12 months, and during March 1936 was kept at 5 watts with results comparable to those at any other time, showing the predominating influence of transmission conditions (rather than power levels) in determining successful communication at 28 Mc.

It will be a pleasure to send W3FAR the bronze medallion Achievement Award given by the League in token of his outstanding ten-meter work throughout 1936. The scoring in the competition depended on a weighting of 50 per cent for QSO-points (one per each 100 miles of completed contact), 25 per cent for development-research work reported, and 25 per cent depending on weekly condition reports to Headquarters. The standing of the four leading participants speaks for itself:



Call	Total QSOs (50 max.)	Research Eqp. (\$5 max.)	Reports (\$5 max.)
W3FAR...	88.6 38.6 (10,664 pts.)	25	25
W8JFC...	61.0 50 (14,170)	10	1
W3BRZ...	53.1 10.3 (2,700)	20	22.8
W9HUV...	47.5 24.8 (7,211)	20	2.7

Honorable mention goes to OE1FH, who would have placed third had formal entries from outside W/VE been eligible. OE1FH had 360 W—VE contacts alone in the year '36. Seventy-seven other individuals were in the running by having submitted at least one weekly report, but failed to enter summaries for consideration. Meritorious work was reported especially from W9JAQ W1EWD W9FWG W5CPT W9GHN W9JZJ W9GBG W8CZR W6EWC and W6JN.

W3FAR's 45-page log is a valuable treatise on 28-Mc. communication. Scoring points dropped from 1820 in January to but 30 in June, rising to more than 1100 per month for September, October and November, with the record of 2619 points for December 1936. W3FAR found horizontal doublets better for reception than vertical antennas, due to polarization of man-made static. He states that his five-wavelength long flat top (167 ft. horizontal) exactly 33 feet above ground (or one wavelength), having lobes running through South America, N. Z., Australia and Japan and bringing S5 reports from all, was preferred to sharper beams tried giving S9 from Europe or other line of fire and fewer reports elsewhere. Careful orientation of any such antenna is required, the horizontal pattern directivity being especially important. In summer, when

(Continued on page 86)

A Simple Bread-Board Crystal-Controlled Transmitter for 56-Mc.

By Harry A. Gardner,* W1EHT

THE question of stable transmitters on five meters is a subject which is rapidly coming to the front with all amateurs who are interested in this band.

In looking over the various circuits which have been published on crystal-controlled transmitters for 56 Mc., it seemed as though most of them were somewhat complicated or used tubes which the average amateur would not have or would not wish to buy just to use on this band, so it was decided to try and see what could be done using common tubes and parts which most amateurs could find in their junk boxes.

THE CIRCUIT

Since the transmitter was to be used primarily on 56 Mc., it was decided to use a 14-Mc. crystal,

nearly sufficient to drive the RK34 on 56 Mc. with this arrangement.

Using the 6A6 as the crystal oscillator and first doubler, however, permitted the use of a second 6A6 as a push-push doubler from 28 to 56 Mc., giving much better output on "five," as would be expected.

The amplifier is conventional push-pull. The RK34 was used because one was available, but a 6A6 would work very well in this circuit, especially if it were used as a buffer to excite a following stage. Type 53 tubes could be used in place of the 6A6's with equally good results.

Care should be taken to see that the filament voltage is at least the rated value. A low value of voltage will cause creeping of the plate current.

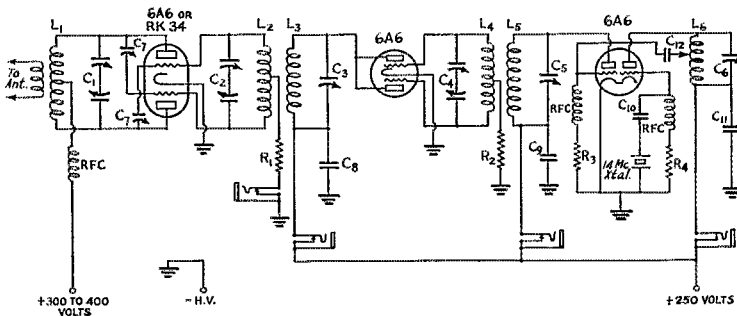

FIG. 1—CIRCUIT OF THE BREAD-BOARD 56-MC. TRANSMITTER

- L₁—4 turns 3/8" copper tubing.
- L₂—3 turns No. 14 wire.
- L₃—3 turns No. 14 wire.
- L₄—6 turns No. 14 wire, tap 3 turns.
- L₅—6 turns No. 14 wire.
- L₆—8 turns No. 14 wire on 1 1/4 inch Isolantite form, tap 3 turns from plate end.
- C₁—Split-stator, 50-μfd. per section.
- C₂—Split-stator, 35-μfd. per section.
- C₃—15-μfd.

- C₄—Split-stator, 35-μfd. per section.
- C₅—50 μfd.
- C₆—100 μfd.
- C₇—2-stator 1-rotor, double-spaced.
- C₈, C₉, C₁₁—0.01-μfd. fixed.
- C₁₀, C₁₂—0.001-μfd. fixed.
- R₁—2000-ohm.
- R₂—10,000-ohm.
- R₃—20,000-ohm.
- R₄—5000-ohm.

thus eliminating as many doubler stages as possible at the start.

Originally a 41 crystal oscillator was used but this was discarded in favor of a 6A6, which gave much better output at low plate voltages. This also permitted doubling in the other half of the tube to 28 Mc. with good output.

In the first circuit tried, the second tube was a 6A6 doubling the output of the 41 crystal oscillator to 28 Mc. in the first half, and to 56 Mc. in the second half of the tube. The output was not

* 80 Washington St., Stoneham, Mass.

CONSTRUCTION

Since the transmitter was experimental, a bread-board arrangement was used. A sheet of Tempered Masonite 24 inches by 10 inches was obtained for this purpose. On one end of this a 12-inch by 7-inch sheet of aluminum was placed, on which the exciter was mounted, which made grounding of the parts easily accomplished.

The order of parts is as follows: Starting at the right, first in line is the oscillator condenser C₆ with the coil L₆ mounted directly behind it. Next to the coil is the oscillator-first doubler tube

and back of this is the crystal, which is mounted in a five-prong socket. Next in line is the first doubler condenser C_5 with the coil mounted directly on the contacts. Next comes the push-pull grid coil L_4 with the split-stator grid condenser C_4 . Again the coil is mounted directly on the condenser contacts. Following this is the second doubler tube, the plates of which are connected in parallel and tuned with the condenser C_3 and coil L_3 , the coil again being mounted on the condenser terminals. Following in line is the push-pull grid coil of the RK34, L_2 , which is mounted on the terminals of the condenser C_2 . The RK34 is next in line followed by its split-stator condenser and coil, C_1 and L_1 . The neutralizing condensers C_7 are mounted in front and back of the RK34.

Jacks for metering the plates of all stages and the grids of the amplifier stage are provided. Grounds are made directly to the aluminum sheet by the shortest possible connections.

All variable condensers are of the midget receiving type, with two of the split-stators being made by coupling two midgets together with a brass bushing. This was done simply because these parts were available in the junk box. The coils were mounted on the condenser terminals to make the leads as short as possible, which is very necessary on the higher frequencies.

TUNING

The tuning of the rig is very simple, and anyone having any experience in the use of crystal-controlled transmitters will have no difficulty in this respect. For others, the A.R.R.L. *Handbook* gives complete details. The neutralizing of the amplifier is conventional, and is very easily accomplished with this type of tube, very low capacity condensers being used. The usual procedure should be followed as described in the *Handbook*.

OPERATION

With 220 volts on the 6A6's, the value of the d.c. grid current in the RK34 was 17 ma., and when the voltage was increased to 300 the grid current increased to 28 ma., which is sufficient for this tube. If the RK34 is to be used as a buffer to drive a following higher-powered stage, the lower value of voltage will be found sufficient; but if it is to be used as a final amplifier with rated plate voltage (400 volts) the higher plate voltage should be used on the 6A6's.

The actual operation of the transmitter ex-

ceeded expectations. Using 220 volts on the 6A6's and 230 volts on the RK34, an output of better than 10 watts was obtained with an input of about 25 watts. This in itself is not startling. But when the outfit was put on the air, the reports



BUILT LARGELY FROM PARTS RESCUED FROM THE JUNK BOX, THIS BREADBOARD 56-MC. RIG GIVES SUPERIOR RESULTS WITH 10-WATT OUTPUT

were most gratifying. The regular transmitter used previously was a pair of RK10's in push-pull as a modulated oscillator, with an input of 100 watts. Using the lower-powered crystal-controlled transmitter, *all reports were as good if not better with 25 watts input as had previously been obtained with 100 watts input to the modulated oscillator, the voice quality was much better, the signal much sharper, and very much more readable.*

This circuit, by using plug-in coils and link coupling, could be used as a six-band transmitter, with a 1.75- and a 14-Mc. crystal. With a pair of 807's or RK39's in place of the RK34, a very nice all-band transmitter for low power would result.

High-Capacity Midget Switches

A NEW type of power switch especially adaptable to primary switching for 'phone push-to-talk has recently been marketed under the name "Micro Switch." In appearance it is entirely different from the ordinary knife or toggle switch, being enclosed in a bakelite case approximately two inches long by one inch high by three-fourths of an inch wide.

The moving contact is mounted on a beryllium copper snap spring which is actuated by a plunger whose end extends through the case. Pressure on the plunger (the actual movement is only about one-thousandth of an inch) snaps the spring and the contacts "make." On releasing the pressure, the spring snaps back to its original position and the contacts open. The contacts have large area and are silver plated.

Several varieties of switch are available besides the normally-open type described above. There is a normally-closed type, and also a double-throw. The plunger tip for mechanical contact is about the size of a ball bearing on the usual model, but the switch also can be obtained with a

(Continued on page 33)

HINTS and KINKS for the Experimenter



A Third-Harmonic Filter for Push-Pull Amplifier

THE generation of odd harmonics of the fundamental radio frequency, which is an inherent characteristic of the push-pull Class-C amplifier, can be greatly reduced by the circuit trick shown in Fig. 1. Instead of tapping the plates on the opposite ends of the tuned plate tank, the plates are tapped in one-sixth of the total coil turns from each end. This type of circuit arrangement provides a very low load impedance to the third harmonic of the amplifier frequency. As the push-pull arrangement already tends to neutralize

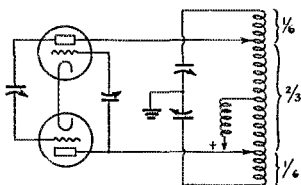

FIG. 1—METHOD OF CONNECTING PUSH-PULL TUBES TO TANK CIRCUIT FOR REDUCTION OF 3RD HARMONIC

even harmonics, this arrangement should prove a desirable improvement over current practice.

For best results, the plate taps should be varied over a small range on each side of the two-thirds point each side of center. By using a wave-trap, field strength meter, or a well-shielded receiver equipped with an S meter and tuned to the third harmonic, the taps can be varied until the third harmonic output or tank current is lowest.

Note that this arrangement will increase the r.f. tank voltage and circulating tank current about 50% for a given amplifier, for the same tube loading. This will increase the circuit Q with its attendant benefits. The disadvantages are that the tank losses will rise slightly and that the tank tuning condenser may arc over. For the same circuit Q as a convention push-pull amplifier operating under the same conditions, only about 44% of the conventional tank C, with proportionately more tank L, will be necessary. Thus the cost of a tank condenser will be about the same in either case for the same circuit merit.

—J. N. A. Hawkins, W6AAR

Improving Efficiency on 56-Mc.

REFERRING to Fig. 2 we have the conventional push-push doubler circuit for doubling to five meters from ten. Its principle disadvantage

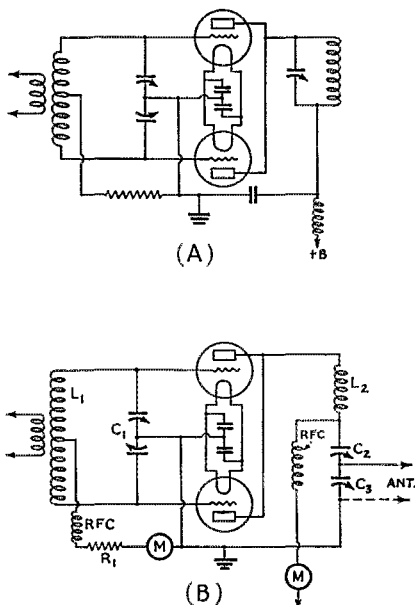

FIG. 2—HIGH-EFFICIENCY PUSH-PUSH DOUBLER CIRCUIT FOR 56-Mc.

- C_1 —25 $\mu\text{fd.}$ per section, double-spaced.
- C_2 —25 $\mu\text{fd.}$, double-spaced.
- C_3 —100- $\mu\text{fd.}$, single-spaced for 45°.
- R_1 —75,000 to 100,000 ohms, 10-watt.
- L_1 —14 turns No. 12, 1-inch inside diameter, turns spaced wire diameter.
- L_2 —6 turns No. 12, 1-inch inside diameter, triple-spaced.
- RFC—Two-inch winding of No. 24 d.c.c., 1/4-inch diameter.

R.F. chokes should be placed at right angles to grid and plate coils and at least two inches from them.

is that the plate tank offers a very low load impedance to the two paralleled plates. This in turn means rather indifferent performance of the circuit from the standpoint of efficiency. In our setup, the plate tank condenser was a 25 $\mu\text{fd.}$ midget and the inductance was a single turn of No. 12 wire about an inch in diameter. Rather a poor LC ratio, and the output was only what might be expected from such an arrangement. One other difficulty at 5 meters has been efficient

coupling between the output of the final stage of the rig and the antenna. This is taken care of rather nicely in the circuit suggested in Fig. 2B.

The front end of this circuit is identical with that at A. However, the plate circuit presents a radically different picture. Series tuning of this circuit is employed with the tank condenser and the paralleled output capacities of the two tubes effectively in series. Furthermore, the plate tank condenser is made up of two units; C_2 , a small condenser for tuning the whole thing to resonance, and C_3 , a fairly large condenser across which the antenna is connected. The voltage drop across C_3 is therefore impressed across the input to the antenna, and by varying C_3 to control coupling, and by employing C_2 to restore the circuit to resonance, any desired degree of loading may be accomplished.

Typical performance of a pair of 45's may be interesting. Operating in a push-pull oscillator circuit, these two tubes could be run at about 40 watts input with rather less than complete modulation. Frequency stability and other characteristics were what they always are with such an arrangement; poor. The same tubes in Fig. 1 could be modulated fully at 20 watts input to the plates, while in Fig. 2B they could be modulated fully at 40 watts input to the plates.

With plate voltage applied (300 volts) the d.c. grid current should run about 12 to 20 milliamperes. Do not apply full excitation to this stage unless the plate voltage is on! The grid leads will break down in the stem and the tubes will be ruined. Probably tubes such as the Taylor T-20 or T-55 or the Eimac family will take the excitation without flashing but not any tube we have tried where all the leads pass through the stem.

The thing can be built cheaply . . . the performance is all anyone could ask for, and 30 watts input to a pair of 45's in this circuit will lick the socks off twice that input to a pair of 10's in a self-excited oscillator. Furthermore, this rig can be modulated very nicely and the envelope patterns look very decent on the oscilloscope.

—B. P. Hansen, W9KNZ

— . . . —

“Junk-Box” Frequency Standard

THE crystal oscillator circuits shown in Fig. 3 probably will have a great deal of novelty for most hams. They are suggested by Christoph Schmelzer, D4BIU, for use in home frequency standards for calibration purposes. He writes:

“I cannot claim any originality for the circuit since I discovered that it had already been used by Cady in his fundamental work as far back as 1924. The thing is an ultraudion with a quartz crystal substituted for the usual tank circuit. The fundamental ultraudion is shown at A, while the corresponding crystal circuit is at B. The circuit works very nicely with crystals up to 7 Mc., but for higher frequencies a small condenser,

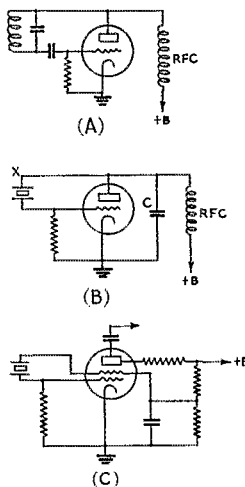

FIG. 3

good beats from the 300th harmonic. Sometimes a small ‘antenna,’ consisting of a 3- to 5-inch length of stiff copper wire, clipped to X, Fig. 3B, helps in getting better signal strength.

“This little oscillator is very useful for many purposes, and its output is high enough to check heterodynes of ‘mixed harmonics’—for instance, the 15th of an oscillator with the 14th of the ‘standard,’ which is very helpful for many calibrating purposes with a crystal of high fundamental frequency.

“A recommended change to get still more harmonic output is to use a screen-grid tube, as shown in Fig. 3C.”

High-Capacity Midget Switches

(Continued from page 31)

half-inch square flat pressure surface which is considerably more comfortable for finger operation. The switch may be operated in any position, and can be mounted on a flat surface by means of wood or machine screws.

For inductive loads such as the primary of a power transformer the switch is rated at 10 amperes at 110 volts. In addition to the push-to-talk application mentioned above, it is also well suited to use as a door switch on a transmitter cabinet, as a vibrator interrupter, and as a contact for a relay. It is manufactured by the Micro Switch Corporation, Freeport, Ill.

— . . . —

Traffic for the Philippines may be routed via W7AYO, Yakima, Wash., who schedules KA1HR daily at 5:30 a.m., PST. Also via W8CUU and W8GDU and Alternates (W6MFX and W6IMI), who also schedule KA1HR.

● I. A. R. U. NEWS ●

Devoted to the interests and activities of the

INTERNATIONAL AMATEUR RADIO UNION

Headquarters Society: THE AMERICAN RADIO RELAY LEAGUE, West Hartford, Conn.

MEMBER SOCIETIES

American Radio Relay League
Associazione Radiotecnica Italiana
Canadian Section A.R.R.L.
Ceskoslovenski Amatérni Vysilaci
Deutscher Amateur Sende-und-Empfangs
Dienst
Experimenterende Danske Radioamatører
Irish Radio Transmitters Society
日本アマチュア無線聯盟 Japan
Liga Colombiana de Radio Aficionados

Liga Mexicana de Radio Experimentadores
Magyar Rövidhullámú Amatőrök Országos
Egyesülete
Nederlandsche Vereeniging voor Interna-
tionaal Radioamateurisme
Nederlandsch-Indische Vereeniging voor
Internationaal Radioamateurisme
New Zealand Association of Radio Trans-
mitters
Norsk Radio Relé Liga
Österreichischer Versuchssenderverband
Polski Związek Krotkofalowcow

Radio Club Venezolano
Radio Society of Great Britain
Rede dos Emissores Portugueses
Reseau Belge
Reseau des Emetteurs Français
South African Radio Relay League
Suomen Radioamatööriyhdistys r.y.
Sveriges Sändareamatörer
Unión de Radioemisores Españoles
Union Schweiz Kurzwellen Amateur
Wireless Institute of Australia

Conducted by Byron Goodman

Cairo:

International representation of amateur radio at the Cairo conference through the I.A.R.U. is now practically assured. At the time of writing, the United States government is proposing the admission of the I.A.R.U. to participation in the work of the conference. Ordinarily only governments and the public-service enterprises recognized by them are given entrance in other than observer status, but international organizations such as the I.A.R.U., proposed by a government and favorably voted upon by two-thirds of the replying governments, are permitted to participate in the work. The United States government is taking the necessary steps with the Berne Bureau and the Egyptian and Spanish governments, and the result should be known within six months or so.

The chances of a favorable vote are very good. The I.A.R.U., through its participation in the C.C.I.R. meetings, has become well-known and its value appreciated. Amateur radio can well be proud that its representatives have been of such high calibre that they have paved the way for this recognition.



JAMES J. LAMB (L.) AND JOHN C. STADLER I.A.R.U. REPRESENTATIVES AT THE C.C.I.R. MEETING AT BUCHAREST

Mr. Stadler, VE2AP, is with the Canadian Broadcasting Corporation, and Mr. Lamb, W1AL, is technical editor of QST.

It should doubtless be pointed out that this recognition does not accord voting privileges or the right to initiate proposals. The Union's delegates may, however, attend all sessions and be heard in comment on such proposals as may be introduced.

The growing strength and importance of national amateur societies in influencing the policies, both national and international, of their governments is perhaps not realized by the majority of the readers of QST. It used to be, particularly in some of the European countries, that the amateur radio society was looked down upon and had little or no opportunity to be heard. Now, however, thanks to a great deal of earnest and steady effort, recognition has been achieved by many. One of the best examples is the splendid

work done by the R.E.F., which has secured the adoption both by a sub-committee and by the entire French preparatory committee of the principle that the 7-Mc. band should be enlarged. No specific figures for enlargement were urged, but it was stipulated that the enlargement should be in the high-frequency direction and as far toward 7500 kc. as possible in consideration of other

services. While it should be made plain that these decisions are not necessarily final, since they were arrived at before any other country's proposals were seen, and there is always the possibility that the French will wish to modify their point of view, it demonstrates clearly the prestige that our member-societies are gradually achieving.

Bucarest:

We receive word from Messrs. Lamb and Stadler via several of the Rumanian stations, but must delay a full report of their work until their return.

The following radiogram from Berlin tells part of a story:

IARU
HARTFORD CONN
THE SHORTWAVE
AMATEURS OF THE
DASD HAVING MET ON
OCCASION OF THE
VISIT OF THE IARU
REPRESENTATIVES IN
BERLIN ARE SENDING
THEIR MOST CORDIAL
GREETINGS TO THE
PRESIDENT OF THE
IARU AND ARRL AND
TO ALL THE ARRL
MEMBERS
GERBHARDT
PRESIDENT DASD



JEAN LIPS, HB9J
One of the best-known Swiss amateurs, Jean is 26 years old and a radiotechnician and serviceman. His splendid operating and activity on all the amateur bands have given him a legion of friends all over the world.

France:

The R.E.F. extends a cordial invitation to all amateurs visiting the 1937 World Fair in Paris to make themselves known at the office of the French society. The address is: R.E.F., 6, square de la Dordogne (122 Bld. Berthier, Paris, 17^e).

Finland:

The fifteenth annual meeting of the S.R.A.L. was held during February at Hämeenlinna. Mr. K. S. Sainio, OH2NM, who has been president for the past ten years, was reelected. Under Mr. Sainio's guidance the society has become thoroughly organized, and is now solidly established with the Ministry of Communications and the Ministry of National Defence. The society has over 235 members, only seven of which are without licenses.

QSL Bureaus:

Supplementing the May list, the following additions and corrections should be made.

- Antigua: R. V. Tibbits, High Street, St. Johns, Antigua, B.W.I.
- Barbados: *see* Antigua.
- British Guiana: *see* Antigua.
- Estonia: E.R.A.U., Box 220, Tallin.
- Luxembourg: J. Wolff, Rue Pierre D'Aspelt 8, Luxembourg.
- Madeira: *see* Portugal.

Netherlands East Indies: Ir. J. M. van Heusden, N.I.V.I.R.A., Palmenlaan 1, Bandoeng.
Southern Rhodesia: *see* South Africa.
Trinidad: *see* Antigua.

M.R.A.C.-A.R.R.L. 56-Mc. Cup Announcement

THE "annual" type of 56-Mc. contest, which in some respects paralleled the annual 28-Mc. competitions in its provisions, did not bring forth the same number of condition reports and points for contacts that was anticipated. In fact, after consultation with the Milwaukee Radio Amateur Club, donor of the beautiful spun-gold cup trophy we now announce "no competition" for the 1936 twelve-month 56-Mc. contest in view of the circumstance that the entries are insufficient in number and quality to make an award justified.

Instead of extending the 56-Mc. Cup competition in the same form, the cup trophy will now be offered for specific work in this frequency range and in two-way DX communication accomplishment at 56 Mc.

The Milwaukee Radio Amateurs' Club 56-Mc. Achievement Award will be made for the first licensed United States amateur work two-way, between continents, properly certified by documentary evidence in accordance with the following:



(1) The licensed United States amateur qualifying must be utilizing transmitter frequencies in the range 56,000-60,000 kc.

(2) The great circle distance covered must be in excess of 2,000 miles and the terminating stations must be located in different continents.

(3) Documentary or written evidence from all parties who are principals in this radio communication must prove to the satisfaction of the officers of the A.R.R.L. and the M.R.A.C. that two-way communication was effected, and show what information was exchanged.

(4) In the event of any doubts in the mind of the judges, or in the event of simultaneous claims based on single intercontinental contacts, it shall be required that the United States station show documentary proof of contact with *two* different stations outside the North American continent, each at distances in excess of 2,000 miles, each confirmed by appropriate and satisfactory written evidence, in claiming the cup award.

—F. E. H.



OPERATING NEWS



Conducted by the Communications Department

F. E. Handy, Communications Manager

E. L. Battey, Asst. Communications Manager

THE A. R. R. L. Copying Bee Results have just been completed and full report on this activity is scheduled for August QST. Three operators turned in 98 per cent correct "copy" of the difficult text transmitted and tie for the medallion award offered by the League in token of highest proficiency in this field. Three duplicate engraved awards will be made, and they go to:

J. Y. Bowman, W5FCQ, Dallas, Texas.
L. R. Clements, W2HHG, East Hampton, L. I., N. Y.
H. G. Martin, W6GVT, Los Angeles, Calif.

Proficiency in copying, in manipulation of the controls, in the ability to put on paper exactly what is sent in neat and legible fashion, or to reverse the process and convert thought into accurately transmitted electrical impulses has always been the aim in amateur radio. The *operator* is the supreme determinant in the communication equation. Equipment may be 100 per cent, but in the hands of the inexperienced it cannot be made to perform . . . or at any rate its performance will fall short of the ultimate. Too little study and attention is given good operating and copying ability by the newcomer today. The *real amateur* above all things knows his code. He has passed through his days of puttering. His ears are keen, and his ability to transcribe has been cultivated by practice. It is no soft proposition to get the Copying Bee texts converted from electrical impulses into black and white. To win the Copying Bee is an indication of the highest ability. It takes a real amateur in qualifications and experience to do it. This is not a matter of luck, but one of amateur training. One must be mentally keen and on his toes to deliver the goods. Our hat is off to all the excellent amateurs who entered the list of competitors for this activity. May there be more of them. Hearty congrats to the winners.

Hamfesting and visiting season now here! Hamfests and conventions are held the year 'round. The summer season, however, offers the best time for arranging meetings and outings. Probably three quarters of all such gatherings for the year will be held in the coming months. Club meetings, held on the average twice each month during the winter season, are in most cases discontinued during the summer vacation, or to amateur radio the "rebuilding" season. There is more incentive to go places and see things when

the roads are passable and the weather favorable. At Hq. the latchstring is out to all visitors. At individual ham shacks also a warm welcome is awaiting the vacationing fraternity brother who drops in for a brief chat, renewing the radio acquaintances of the past season.

This is just a hint to the radio newcomer to take with him in his summer travels a call book and batch of QSL's. The winter has been devoted to making new radio acquaintances (unless you are one of those deplorable fellows who never says anything but 73-CUL after swapping reports) and building up individual stations and station records. But there's more to amateur radio than this. With this season our advice is to lay aside the restless pushing of self and station for "more DX," "more traffic"—and competition for records. It is healthy to vacation in the vacation season. To be a balanced amateur learn to find the fullness of enjoyment in the fraternal relationships that are possible within the framework of amateur radio.

Let us visit our fellow hams, not to boast of what we have done in amateur radio, but to broaden our interests to include theirs. Many a useful idea and notion may be found in stations visited that will be adaptable to our own; constructive plans for the new unit or schedule work to be started in fall may result from impromptu discussion. It may be time to try new sides of our hobby; there is the subject of net organization and amateur emergency work and the different A.R.R.L. appointments to the qualified to be discussed. So we say one should take in all the meetings possible, visit all our special ham friends we can. This is bound to be mutually pleasant and profitable, especially if we make the visits with no special personal aim in view except to swap talk about apparatus, new and old, and operating of the past, and future plans. Take portable set and log if you can, but at any rate let the call book be your companion. Take your F.C.C. operator license if you expect station operating courtesies to be extended. Be tactful and considerate of others in your visiting—the folks visited may have plans, too. If you are making a first-time visit, make it just a short friendly visit to say hello. You will be pleasantly surprised we are sure.

This is the season for true rag chewers, and all

others with the real amateur spirit, to cement and expand our personal friendships and acquaintances when there is opportunity to get about and cover some of the miles our signals have spanned by actual contacts and station visits. The Rag Chewers Club is our over-the-air exemplification of the spirit we should show our brother amateur. Summer is the best time to plan meetings and visits. We can learn much from our travelling and visiting. We commend to you the ragchewing idea. As we have built stations, let us neglect no opportunity to build a circle of true radio amateur friendships, and expand our breadth of acquaintance with these friends at every opportunity. The technical aspects of amateur radio are educational and worthwhile; the fraternal and personal possibilities have even greater potentialities for enjoyment.

—F. E. H.

W1AW on Summer Schedule

Effective July first, regular evening schedules at W1AW will be discontinued. There will be operation in regularly announced field organization activities as usual, and intermittent operation by members of the A.R.R.L. Headquarters Operators Club who drop around evenings. The change in schedule will facilitate plans and progress on new station units to be placed in operation next season.

W1AW's official broadcasting station program addressed to League members will continue with daytime transmissions, once each day except Saturday and Sunday. The transmission schedule will be as follows until further notice:

Frequencies—Simultaneous telegraph tape transmissions on 3825, 7150, and 14,300 kcs.

Time—1.00 P.M. E.D.S.T. (Noon, EST; 11 A.M. CST; 10 A.M. MST; 9 A.M. PST).

Speeds—Monday, Wednesday and Friday, 20 words per min. Tuesday and Thursday, 15 words per min.

Ham Gatherings

The annual Spring Hamfest of the Cambridge (Ohio) Radio Club will be held Sunday, June 27th, at Cambridge. Director W9ZN and W1QP will be the principal speakers.

The Montreal Amateur Radio Club's Annual Picnic will be held July 1st at the Pine Grove Park, Chambly Canton, Quebec, fifteen miles from Montreal on the Sherbrooke Highway. For those who travel in their own automobiles, admission will be 25 cents for car and driver and 10 cents for each passenger. Those who want to travel by rail can do so. The Southern Counties Railroad station at that point is right at the entrance to the grounds. Bring the kiddies and enjoy a good day's outing . . . swimming at the Old Fort, one mile from the grounds . . . 56-Mc. activity, sports, etc. For further details see VE2LV (phone York 1557), VE2CO (Elwood 8270), VE2CR (Walnut 3143) or VE2KS (Elwood 4321).

The annual WIMU (Wyoming, Idaho, Montana, Utah) Hamfest will again be held at Jenny Lake, Wyoming, on July 31st-August 1st and 2nd. Anyone who has attended a WIMU get-together needs no urging to be on hand this year. Complete information may be obtained from Henry H. Summers, W7AEC, Pinedale, Wyo.

W9XAZ

The Milwaukee Radio Amateurs Club, Inc., is again broadcasting an amateur program over the Milwaukee Journal station W9XAZ on a new frequency of 26,400 kcs. The program goes on the air each Saturday from 3:00 to 4:00 P.M. C.S.T. Reports and comments are solicited and should be addressed to the Milwaukee Journal Radio Station, W9XAZ, Milwaukee, Wis.

56-Mc. Field Day

In the last few years VE3 amateurs have taken a keen interest in 56-Mc. work and have been repaid by some very fine two-way contacts. VE3KM, VE3NH and VE3OJ of Hamilton, and VE3KV, VE3MJ and VE3ADO of Toronto were invited to participate in the Field Day test of the Western New York 56-Mc. Club on May 23d. In 1936 W8 and VE3 enjoyed their first two-way QSO across Lake Ontario. This year they were out to better last year's record.

The Hamilton stations assembled their portable gear on top of Hamilton Mountain; VE3KV and VE3MJ set up in Toronto and VE3ADO transported his portable equipment 90 miles to Port Colborne. With the help of VE3XX, VE3HR, Mr. Robinson and Mr. Pennock, 3ADO succeeded in setting up the apparatus on top of the grain elevator at Port Colborne. From there they made successful contacts with portable W8RV, W8ZOP, W8OQS, W8MLQ, W8EMM, W8NOR, W8CDM, W8BDM, W8HQC, W8POL, VE3HR and mobile W8GU, who was in the hills near Erie, Pa. The home station of VE3ADO at Toronto was also heard. The contact between VE3ADO and W8RV marked the first 56-Mc. communication between Port Colborne and the United States. A letter from Mr. Paul D. Behning, Tulsa, Okla., reports that he heard portable VE3ADO on May 23d at 12:07 C.S.T. W8CXG and W8OPO were also heard in Tulsa on the same day.

On the New York end, W8RV, Hobart Hyde and Jack Von Scheidt left Buffalo with a car full of 56-Mc. equipment, heading for a hilltop near Colden. They were on the air by shortly after 1:00 P.M. First contact was with W8HQC, operating at Elma, N. Y., a distance of about 14 miles. Then came the contact with VE3ADO, setting a new record. From then on contacts came thick and fast. W8CDM, set up on a 2100-foot elevation at Cherry Creek, N. Y., had a message for North Tonawanda. W8RV relayed to W8NOR right in North Tonawanda. During the afternoon a kite was sent up and about 300 feet of wire released. A decided increase in signal strengths was noted, both in transmitting and receiving. Other stations worked by W8RV included W8EXX, Sardinia, W8MCW, Batavia, W8MKB, Rice Hill and W8DHM, Warsaw. The complete list of stations logged: W8HQC BSM EXX MKB GDM OBK NRC MLQ OQS IOW CMW GBK DSB W2PNA and VE3ADO. W8GU, who operated near Erie, Pa., using a c.c. transmitter with an input of one watt, made the record contact of the day—with VE3ADO.

"On Saturday evening, January 9, 1937, a drizzling rain began to fall, freezing as it struck. By the following morning all Tyler (Texas) was a mass of ice, with all communication lines down and no electric power except for a small portion of the downtown section which was supplied from a small auxiliary plant at the power company's sub-station. Wires and trees were down all over the town. My antenna sagged low under the strain of a two-inch diameter of ice on a Number 12 wire! Fortunately Mr. H. Knapp was marooned in the city with his R.C.A. magic show coach, which carried a 3 kw., 110-volt a.c. power plant. He cooperated unhesitatingly and we were on the air: 1.75-Mc. 'phone, input 500 watts. A fairly large number of messages was handled, mostly into Dallas and Houston, with stations KACU, W5EKU, W5AVH, W5OL, W5BDE, W5FQJ and W5GBU cooperating. Messages were handled for two days until Western Union put a wire through. Communications were handled for W.U., Postal Telegraph, Texas Power and Light Co., Southwestern Bell Telephone Co., Tyler Morning Telegraph and Courier Times and a few individuals."

—J. M. Burke, Jr., W6EME

W6FBW would like to see a skeleton trunk or "owl net" formed connecting the east and the west through the summer months. A route made up of several reliable stations is needed to clear east-bound traffic from the Central California Net which operates the year 'round. Interested operators please get in touch with W6FBW, stating frequency and time available.

The article by Mr. Jack Burrage, VK3UW, wins the C.D. article contest prize this month. Each month we print the most interesting and valuable article received marked "for the C.D. contest." Contributions may be on any phase of amateur operating or communication activity (DX, 'phone, traffic, rag-chewing, clubs, formalism, etc.) which adds constructively to amateur organization work. Prize winners may select a 1937 bound *Handbook*, QST Binder and League Emblem, six logs, eight pads radiogram blanks, DX Map and three pads, or any other combination of A.R.R.L. supplies of equivalent value. Try your luck. Send your contribution to-day!

Making the Most of QSO's

By Jack Burrage, VK3UW*

THE more one puts into a QSO, the more one gets from it in return. The full benefit and enjoyment of a contact with another ham station cannot be obtained in one of those frantic three minute hook-ups, which are, unfortunately, so common.

Perhaps a little parable will help illustrate the point. Scene is a starry evening in southern Australia. A certain VK3 has managed to elude the YL and finds he has a free evening. Naturally it is not long before the bug bites and he gallops for the shack. He soon has the filaments fired up. On goes B + to the t.r.f. and he dons the caps. "Ha!" A host of W8's coming through nicely on 14 Mc. The "trannie" gives a jolt as the juice goes up to the outraged tens and he pounds a snappy CQ DX. "UR RST so and so," sends his nibs to the W8 who has answered. "QRU 73 PSE QSL." And he's calling CQ again.

At the end of half an hour his fist is feeling the strain a bit. His eyes wander to the log. "Six W8's in half an hour—nice work!", he gloats. The reports received column indicates practically the same report from each station, as would be expected. And here endeth the parable.

Oh, ye thoughtless ham, Would it not have been far better had you spent that half hour in one edifying QSO? All you have learned is that your sigs are RST 569 around Ohio; and that was stale news after the first contact. You have probably given those W8's varying reports. Would it not be interesting to know what equipment and power each is using? Of course it would. Then would it not be worthwhile to investigate their antennas, and find which antenna is laying down the best signal? Then perhaps W8-so and so would be interested in what you are using. Don't you think he would be interested in that new tube you tried or in that new modulation arrangement you worked out? If you think so, why not shoot the dope on that across, too? Why not a few friendly remarks about yourself, your occupation and interests other than radio? And there's always that topic of universal interest—the weather. You will find it most satisfying to get similar information and details in return. In fact, you will record "FB QSO" in the remarks column of the log and you will mean it. You will have enjoyed that QSO, and learned far more than if you had raced through a string of senseless contacts. What's more, you will have made a friend. That QSL you request will probably be written out on the spot instead of forgotten about. Next time he hears you, you will get another shout for sure.

I don't mean that we should rag-chew like a lot of old women. No more do I suggest that you send a lot of dope when you receive a report of poor readability. We must respect the other fellow's patience and nerves. What I do advocate is reasonable time spent on a contact, and an intelligent exchange of information whenever conditions permit.

This exchange of ideas and opinions does more than anything else to advance the art of radio and, at the same time, encourages and engenders that friendly ham spirit of which we are so proud. You know how you yourself feel when you receive a curt "QRU CUL" when you were looking forward to an enjoyable QSO. It certainly causes no quickening of the ham spirit.

* 12 Terry St., Deepdene, E. 8, Victoria, Australia.

Let's hear more swapping of news and ideas. Get to know the fellows you contact. Share your ideas with them, and invite hints from them. You will find amateur radio "richer" and more enjoyable.

Re Official 'Phone Stations

IF YOU have a good 'phone, why not drop a line to your S.C.M. (address in each QST) for application blanks for O.P.S. appointment? A.R.R.L. Headquarters will also be glad to send information regarding O.P.S. work to any amateur who inquires, including sample copies of bulletin material as long as extra copies last. Every high quality 'phone station which is operated in line with correct practices should be included in the Official 'Phone Station roster. Since the last additions to the O.P.S. list appeared in QST, the following stations have received O.P.S. appointments:

W1IMV	W3CXE	W5CJB	W6NOW	W9TKD
W1ANP	W3DOG	W5EYP	W7FLG	W9JVM
W1HKK	W3FVQ	W5DVE	W7CJK	W9MXX
W1GZL	W4EPZ	W6CAH	W8BQA	W9THB
W1GOJ	W4BYA	W6MNT	W8CVZ	W9TYJ
W1AW	W5BMM	W6JXB	W8NYP	W9ONR
W1IEI	W5DOK	W6LPN	W8LTI	W9FRC
W2JMX	W5FQB	W6KEI	W8MBW	W9PNV
W3FBG	W5BLQ	W6MYO	W9KBT	VEIEV
W3FGJ	W5DKR	W6DUB	W9TLM	VEIJC
W3FVF	W5GCV	W6AEX	W9ECY	VE3NX
		W6ZAE		

Poor conditions did not daunt the spirit of the O.P.S. gang during the quarterly get-together on the air April 24th and 25th. Scores actually ran somewhat higher than in the previous party. W8LUQ, with 3632 points, leads the list for the third consecutive time! He made 39 contacts in 16 sections. W8CGU is again in second place, giving LUQ a good battle. Close on his heels comes W2HNP, and in fourth place W4DCQ. Fourteen scores ran over 2000. The complete list of high scorers herewith gives full details on accomplishments.

O.P.S. appointees are now looking forward to the next air-gathering—on July 24th-25th.

Station	QSOs	Sections	Heard	Score	Power	Section
W8LUQ	36 + 3	16	16	3632	400	W. N. Y.
W8CGU	23 + 7	17	8	3179	200	W. N. Y.
W2HNP	37 + 1	16	2	3104	380	N. N. J.
W4DCQ	37 + 2	15	3	3015	175	N. C.
W3EOZ	35	15	4	2745	700	E. Pa.
W8FIP	32	16	5	2720	200	W. Pa.
W2CBO	29 + 1	17	4	2686	500	E. N. Y.
W3AJJ	27 + 1	17	4	2516	150	Va.
W9TTA	26	16	11	2432	200	Ind.
W8MOL	33 + 1	13	3	2288	400	W. Va.
W2DC	31 + 2	13	5	2275	500	E. N. Y.

Call	QSOs	Power	Score	Call	QSOs	Power	Score
W3FGJ	29	300	2265	W8JFC	22	95	1416
W8HFR	25	225	2115	W1DWP	19	150	1404
W3BBV	25	200/250	2028	W8CHT	15	100	1111
W2FFY	26	400	1690	W8EMV	20	125	1080
W1EAO	24	400	1656	W1GMD	16	120	1040
W8KNF	21	200	1644	W1COI	15	45	960
W6ITH	15 + 7	1000/80	1612	W3EZ	18	40	954
W9HSF	25	400	1572	W8MBW	15	300	950
W3BIG	21	150	1443	W9KEF	16	110	864
W3BRZ	20 + 1	150	1428	W2IKV	15	200	850

Brief

W6ONE (ex-W8EFW) has discovered a place called "Hams Station, Calif.," listed in a tourist guide. The information given reads, "HAMS STATION, Amador County, 37 mi E. of Jackson; 84 SE Sacramento; 177 SF, 426 LA, 551 San Diego, US 99 N. to Stockton. State 8 E. to Hams Station. Elevation 5450. Mining, grazing." Now if there is a real ham station there. . . !

W6KFC Leads April O.R.S. Party

IN SPITE of generally adverse conditions due to severe magnetic storms, and practically all signals sounding "hollow" and lacking in "fullness," and with one period of complete "fade-out," many good scores were made in the quarterly O.R.S. get-together, April 24th-25th.

For the first time a "west coast" operator tops the list of high O.R.S. Party scorers—W6KFC with 41,724 points. In second place is W4NC with 35,825, and old-time O.R.S. party-ite W9AUH places third. It was a "large" party . . . 16 scores over 20,000; 40 over 10,000! The figures below will tell the complete story of the leaders' success.

The next party comes on July 24th-25th. All O.R.S. appointees should plan to take full advantage of what it offers—operating fun with brother appointees plus the chance to give the station a real work-out.

Station	QSOs	Sections	Heard	Score	Power	Section
W6KFC	118	49	25	41724	150	Ariz.
W4NC	137 + 1	50	19 + 3	35825	600	N. C.
W9AUH	163 + 1	50	40 + 5	34150	900	Ky.
W2AYJ	118 + 2	45	55 + 28	33314	500	N. Y. C.-L. I.
W1TS	133	43	28	29698	50/250	Conn.
W9BNT	139	51	23	29654	175/350	Nebr.
W3NF	119	39	41 + 32	28275	...	E. Pa.
W1AW(Had)	127	39	47 + 4	27885	100/200	Conn.
W3PTK	123	43	58	27588	90	So. N. J.
W2HXI	112	40	14	23960	250/300	No. N. J.

Call	QSOs	Power	Score	Call	QSOs	Power	Score
W1BFT	119 + 5	...	23595	W5DXA	79	300	14350
W4DWB	108	35/50	23560	W3EOP	78	...	14084
W3ECA	108	50	21204	W8OFO	77	400	12818
W8LII	107	100/150	20720	W1AFB	76	175	12617
W8GUF	106	100	20680	W9KJX	87	120	12077
W8BYM	107 + 5	150	20200	VE3QK	71	70	11798
W1UE	106	50	19034	W9RUN	66	90	11692
W2GGE	100	150	18445	W7FVK	64	60/30	11536
W2DXO	100	300	17850	W2JHB	65	100	11097
W3GPC	90	57	17460	W8WE	67	300/350	10623
W2GVZ	96	900	15624	W2JBL	65	35	10525
W3BKZ	90	250	15624	W3FPQ	68	300	10368
W3GKZ	79	200	14850	W9DMY	53	160/250	10108
VE3AEM	86	100	14770	W6LMD	52	100	10056
W8JKO	96	190	14504	W8AQE	60	58	10036

The Official Relay Station appointment is primarily a traffic appointment, for amateurs interested in regular traffic work, schedules, etc. Opportunity is given all O.R.S. appointees to test station performance during quarterly QSO parties. The pleasure derived from these get-togethers can be fully appreciated only by participation. If sincerely interested in traffic handling, take steps now to obtain O.R.S. appointment! Drop a line to A.R.R.L. Headquarters or direct to your S.C.M. (address in each issue QST) for complete details on how to become O.R.S. Act now and get ready for the big fall/winter season ahead.

Newly appointed "reliables" now included in the roster of O.R.S. are as follows:

W1IIV	W1KIN	W5ETM	W8GUN	W9KJX
W1JMV	W2JUC	W5DOK	W8VP	W9JVM
W1ITI	W3GJY	W5GCM	W8ICC	W9YNG
W1HXZ	W3FKZ	W5GHF	W8GUF	W9RUN
W1FNM	W3GJP	W5WG	W8GBC	W9DHS
W1AW	W3ECA	W5FRB	W8NUV	W9ZT
W1BKG	W3GMK	W6DH	W8CLL	W9SDP
W1SI	W3GPC	W6NQB	W8KYJ	W9WBI
W1JFY	W3EPW	W6GHD	W8OHW	W9YC
W1IZW	W3KA	W6IMI	W8NLE	W9TDR
W1EMG	W3ETA	W6LBB	W8OLV	W9RWS
W1IIN	W3DGC	W6NSN	W8AXH	CM2OP
W1JHK	W4DWS	W6OKF	W8PCL	VE1JK
W1JYE	W4EAM	W7DWF	W8FWU	VE2KF
W1KJP	W4QK	W7CDH	W8OFE	VE2JK
W1EFW	W4MS	W7PFN	W8NSE	VE3SS
W1JFN	W4EBB	K7ENA	W9WVJ	VE3DH
W1IZO	W4ECP	K7ELM	W9OOU	VE4PQ
W1HGV	W4DXI	K7BOE	W9UEG	VE5SW
	W4AMX		W9WKP	

BRASS POUNDERS' LEAGUE

(April 16th-May 15th)

Call	Orig.	Del.	Rel.	Extra Del. Credit	Total
W2BCX**	17	15	1640	—	1672
W7DUE	103	24	724	—	851
W6ITH	191	243	212	198	844
W6DH	66	212	328	212	818
W1INU	226	122	295	—	643
W1HH	23	31	582	6	642
W3SN	108	121	387	—	616
W3QP	126	227	—	226	579
W1HSX	80	68	386	40	574
W6JTV	87	194	166	106	553
W2HZY*	18	14	504	6	542
W6LMD	3	73	395	64	535
W5MN	41	176	252	59	528
W7EBQ	5	28	474	12	519

MORE-THAN-ONE-OPERATOR STATIONS

Call	Orig.	Del.	Rel.	Extra Del. Credit	Total
KA1HR	908	466	258	452	2084
W6OW	129	209	698	168	1204
W9BNT	44	94	508	—	646

*These stations "make" the B.P.L. with total of 500 or over. One hundred deliveries+Ex. Del. Credits also rate B.P.L. standing. The following one-operator stations make the B.P.L. on deliveries. Deliveries count!

W6IOX, 362	W7APS, 166	W3FXZ, 116
W6GHD, 322	W5CEZ, 127	W1HOT, 109
W6BQI, 216	W1IOR, 121	W6BQO, 108
	W8CSE, 116	

A.A.R.S.

Call	Orig.	Del.	Rel.	Extra Del. Credit	Total
WLNK (W2BCX)**	11	9	1154	—	1174
WLMA (W8YA)	12	27	588	23	650
WLMK (W6XMI)	74	119	390	—	583

MORE-THAN-ONE-OPERATOR STATIONS

Call	Orig.	Del.	Rel.	Extra Del. Credit	Total
WLM (W3CXL)	234	195	1832	—	2261

A total of 500 or more, or 100 deliveries Ex. D. Cr. will put you in line for a place in the B.P.L.

* Mar.-Apr.

** Includes Mar.-Apr. total.

Did you say "rag chew"? Here's one lasting for over 5 hours! On May 9th W4DUU/4 (of Greenville, Ala., QSO'd W4DMQ, Chicktion, Ala., from 8:45 P.M. until 12:10 A.M. (May 10th)—a solid 5 hours, 25 minutes of rag chewing.

"Our 'Mission Trail' 160-meter 'phone traffic net is still going FB on 1804 kcs. daily at 7:30 P.M. The revised membership list: W6MYL NOG BU OAO KHW NOE MVA KKL HVZ NAL OJE JRU JFQ LMF OEC NVR OND HHE FIS MPS NMT MUN."

—W6JRU, O.P.S.

Correction

On page 23 of the May issue of QST, in an article by F. E. Handy entitled "DX Competition Policy," a footnote statement is made that among the scores of disqualified calls listed prominently in August '28, August '30 and August '31 issues of QST in the official report of previous events, was the call of W2BYP. The italicized "and" should have read "or." Our attention is called to the fact that W2BYP was not disqualified in '28 or '30, and that he was disqualified in 1931 upon the report of a single observer. This station was disqualified in the 1937 competition on the basis of three off-frequency reports. We are pleased to make this correction.

Speaking of DX Competitions, our footnote above referred to had as its purpose emphasis of the fact that the policy of disqualification for off-frequency work in A.R.R.L. activities is a continuing one. Plans for the 10th International DX Competition involve F.C.C. monitoring cooperation for off-frequency operation and improperly-filtered or broad signals.

How's DX?

How:

Comes now a brief discussion of call bootlegging and "phonies." Without delving into the ethics of the thing, and considering it only from a DX standpoint, there is little or no objection to this type of operation as long as all of amateur radio is not jeopardized by the bootlegger operating in a manner that draws attention to his illegality, such as by interfering with commercials outside the bands. To a DX'er, contacts with these stations represents legitimate DX, and that's good enough. But the donkeys that get in our hair are the poor misguided souls who think it's awfully funny to loosen the coupling to their antenna and sign a nice juicy DX call when they have an assigned call of their own. They probably take great delight in listening across the band and hearing stations hopefully calling. But then they probably took delight in the reaction of the girl who sat in front of them in school the time they dipped her curls in the inkwell. To them we say, "If you can't have fun with wireless without going phoney, ham radio isn't the hobby you want."

Of course, none of this would have been mentioned if we hadn't spent an hour calling DX4U and NT22U. . . .

Where:

From various sources, including VE3DA, W4MR and W1TS, we learn of a station in a country you'd like to get. 2PXX (14,330 kc., T7) gives his QRA as Paul Betechevery, Boite Postal 61, St. Pierre de Miquelon, and asks for his QSL's under cover. The only dubious thing about it is that St. Pierre and Miquelon are two separate islands, so we don't quite understand that QRA. And the official prefix is

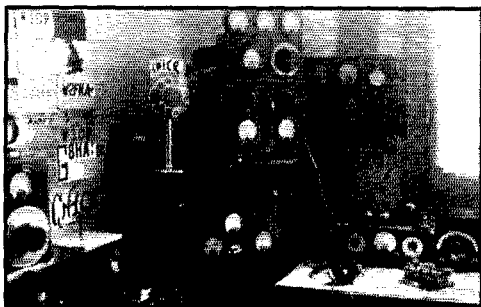

CN1CR, THE ACTIVE STATION OF CAV. CRISTIANI CARLO IN TANGIER

Using an MOPA with two 6L6's, 30 watts is run to the amplifier on 7 and 14 Mc. The receiver is a TRF affair. Both 'phone and c.w. are used, and CN1CR is active almost every day from 2200 to 2400 TMG and Sundays during 0600-0800 TMG.

FPS. But maybe we'll see his QSL card one of these days From W2GTZ and W8OUK we bring a gleam of hope for those who are still patiently hoping that the Asian card from OS1BR (14,440 kc., T8) will show up. The story is that OS1BR is prospecting for oil in Hejaz, has about 500 QSL's already made out but no opportunity to mail them yet, and that the "Sulliman" address he gave before was correct but apparently something went wrong. The operator is an ex-W5 W6OGA (ex-W2DEU) sneaked one over on the boys when he worked SM5VQ (7130 kc., T7) the other morning. The station was that of the Swedish East Asiatic Film Expedition (reported in the May issue as using SMVQ) located near Canton, China, at the time Our British friends certainly get the

breaks. For example, we learn from W2ADQ that G2YY snagged a honey in the form of TA2BS (14,030 kc., T5), and another signing FN1C (14,070 kc., T9x), which should be in French India On this side of the water, W3DAL, W4MR, and W4ZH pulled ST2BN (or is it ST2BM?) out of a tall silk hat around 14,355 kc. The note is T9 XOH1T is the Finnish training ship *Souomen Joutsen*, according to W2HCE. They use 50 watts of c.c. on 7 and 14 Mc., and you can send your card to XOH1T, care of Lieut. Colonel P. Pertamo, Chief of Laboratory, Puolustusministerion Sähkilaboratorio, Helsinki-Linnak. 16, Finland W3GAU reports working a station signing EL2A on April 27th, but he was so loud, and the other EL2A is home, that we think it was a phoney Incidentally, W2IOP keeps a sked with EL2M three times a week. Larry passes along the QRA of FY8A (14,370 kc., T9) as Box 62, Cayenne, French Guiana If you work FKXL (14,280 kc., T9), like W9LJW did, don't think he's a phoney because he says he's at Clipperton Island. He may be a phoney, but Clipperton Island shows up on the map about a thousand miles northwest of Rapa Nui (Easter Island to those of us who buy balcony seats) G2YY and W3CHH report EA2BH (14,035 T9x) as active in Jaca PZ1AB tells us that the Surinam government is opposed to amateur radio, so if you haven't already worked a PZ you soon may find it hard to scare up that country Although W2GTZ had his card returned to him marked "unknown," W3EPV received a fine acknowledgment from OX3M. The OX station, which had been located at Foreland, Greenland, is no longer in existence, the operator having returned to Denmark W3GAU didn't do so badly when he worked VE5RA (14,380 kc., T8), since the VE5 is located at Resolution Island, Baffin Land. You can QSL via CGS, N. B. McLean, Dept. of Marine, Quebec. P. Q. It won't pay to be impatient, though. The mail is delivered once a year!

When:

For a few days this month we thought that the prediction we have been making about a trans-atlantic 58-Mc. QSO becoming an actuality had come true. We had reports that a W1 and a G5 had worked two-way, but we haven't been able to confirm it yet. In the meantime, the boys are down there still plugging away. XUSZW, whom you have probably worked on 40, is on 5 meters daily at 13 GMT, sending test signals, and W6MEK advises that W6GEI is on daily with 250 watts of c.c. and an "H" type antenna beamed through the northeast. He has been heard in Maine. . . . Ten meters has been acting up, and it has been known to stay open until as late as 2 A.M., according to W5GGX in New Mexico. W4ZH has been working VK, ZL, LU, PY, ZE, and K6 on ten, but says that no Europeans have been coming through W6KUR reports a QSO with HS1BJ (14,060 kc.), and rates it as rarer DX than ZK1AB. Waal, mebbe W2HCE gives a few 'phone frequencies: SP1HH (14,140 kc.), FT4AG (14,375 kc.), HR2A (14,386 kc.), and OQ5AA (14,140 kc.) If it's Asia you need, W6LIF suggests J3FZ (14,045 kc., T9) and J3FP (14,125 kc., T9), W2GTZ gives us XUSDN (14,030 kc., T7), W6MCQ lists VS1AA (14,020 kc., T8), VS1AI (14,030 kc., T7), VS1AN (14,270 kc., T8), and J8CF (14,260 kc., T9); W9T5V worked J7CR (14,275 kc., T9x), and W3DAL tells of TA3CF (14,360 kc., T9e) in Turkey, but is inclined to think him a phoney PK4KO (14,140 kc., T9x) says he is the only Sumatran station on 20 XTF5Q (14,100 kc., T5), worked by W6CIS, was a ship west of Iceland. TF3FZ (14,380 kc., T8) worked by WLEH, is located at Akureyri W2IOP got a rare one when he worked UØKK a short time ago. The UØ's are way over in Asia Don't be surprised because YR5AA has a d.c. note now. Jim Lamb is over there for the C.C.I.R. meeting and has probably been visiting ham stations on the side.

What:

We have no startling technical advance to give you this month, but we would like to pass along the word from W6MCQ. He was having some trouble raising Europe and Africa on 14 Mc. despite an apparently good horizontal sky-wire. He was talked into putting up a half-wave vertical and since then (early this year) has worked 14 Africans and 47 different Europeans. W6OIS is another who backs the vertical as a help towards better DX. Naturally, it won't be a cure-all, but at least it's worth a try, especially if you're not getting out the way you think you should.

Who:

Here are some of those active fellows in the rarer states: New Mexico has W5GEY, using an e.c.o. in the high end of 14 Mc. A Vee beam for Europe will be up soon. Wyoming has W7CEO (14,184-kc. 'phone) with a kilowatt, W7GGG (14,020 kc.) with 500 watts, and W7BAH (14,206-kc. 'phone) with 200 watts. Evening, their time, is the best period to look for them We'd like to hear from some active DX stations in Nevada and the other rare states, to pass along the word to the foreign stations looking for WAS I1MG (14,060 and 14,120 kc., 'phone and c.w.) is on week-ends looking for Asia and Australia for his 'phone WAC ZS1AH on the high end of 14 Mc., needs Montana for WAS, and ZL1FE is looking for New Mexico, Nevada and Vermont, for the same reason If anyone should be called a "G-Man" it's W1WV. The latest report has it that he has worked 665 different G's. Gee! W9RBI thought he would try a little of this QRP stuff the other day during a 14-Mc. 'phone QSO with 1DNL. The final is a T55, but by taking off the regular power supply and finally ending up with the 6-volt tap of a dead B battery, he was running .02 watts input and was still RS43. It figures out something like 50,000 miles per watt, on 20 'phone This QRP stuff isn't the bunk. We worked this fellow W5CPT the other night and had a swell chat. His 8 watts was bouncing through in fine style, a good S7. Latest DX there is J3FP (14,120 kc.), J3FZ (14,060 kc.), PK1XB (14,130 kc.), PK4KO and KAIER (14,280 kc.). WAC 12 times, and 47 countries And to clinch the case, W3GHB worked J2CC with a crystal oscillator, doubling in the plate circuit W8OMM is something of a scientist. A rather complete survey discloses that his liquor business runs only about 45 per cent normal on nights when the skip is poor. It fluctuates with magnetic storms as well The last fellow we thought would fall for the "DX Expedition" gag is W6QD, who works plenty of stuff, but he sent his money in along with the others. We didn't have to return it, though. The check wasn't any good!

WAC:

Latest 'phone WAC's are to LU8EN, F8YG, HB9A, G5PT, W7MD, W1AQM, W8AM, W4BMR, W3APO, W6CQG, VP6YB, G5XG, G6WY, PA0WV, W2HCE, G5PB, ON4SS, LA1G, GI6TK and W6MLG To G. W. Perdew, K8CMC, goes the honor of the first K6 'phone WAC W9TQW made his WAC with 30 watts input to an 801 W1EH, K. B. Warner to you, returns to DX activity with some pretty nice work. Among other things, he worked OK1FZ, PY2HM, SU1EQ, U9AV, VK3QK, and W9DOP, in 6 hours, good time for a WAC in the W1 area.

—W1JPE



In six months W1ZB has handled about 150 messages bound for WCFT (Schooner *Yankee*) and about 250 from WCFT.



Have you looked at the expiration date on your license recently? It does no harm at all to check occasionally. Avoid the embarrassment of having your license expire through your own carelessness and failure to renew.

N.C.R. Goes to Court

By F. O. Archer*

UNIT FOUR, Section Two, Astoria, Oregon, Division of the United States Naval Communication Reserve can be numbered among the many other units of this kind throughout the country that are ready to spring into action at a moment's notice, be the cause flood, storm, or disaster.

Perhaps no other unit was launched under happier circumstances than this one. Feeling the need in the Lower Columbia River region of a swift, sure means of emergency communications to replace regular communication channels in time of disaster, the Clatsop County Court, working shoulder to shoulder with virtually every public-spirited organization and individual of Astoria, Oregon, has assured itself of a never-failing means of radio contact, and as a result the Navy has here a Communication Reserve Unit which bids fair to being one of the finest of the country.

Communication Headquarters was established in the County Recreational Center, Astoria, Oregon. An operating room, office, and a schoolroom containing blackboard and a training table fitted with code practice oscillator and ten operating positions are provided. Space requirements do not permit a full technical description of the portable transmitter-receiver circuits with their associated power supply. Interested readers may gain some insight from the following general specifications: The transmitter uses an 807 crystal or m.o.p.a. with crystal switching arrangement. Parallel 807's are in the amplifier, 50 watts nominal output; 'phone or c.w. High level modulation is employed with Class A B 6L6's. The unit operates from light socket, or from portable 300-watt gas engine-driven generator. The receiver is a standard super-het with one iron core i.f. stage, a 6L6 feeding six-inch dynamic speaker or headphones. All units are self-contained in handsome, cracklefinish, carrying case including antenna, antenna reel, key, and hand microphone. All equipment has been furnished by the civil authorities.

Following the public-spirited example set by Clatsop County, the County Courts of Tillamook, Coos and Lane Counties, Oregon, are now engaged in the preliminary stages of setting up similar N.C.R. units. Information in greater detail, concerning either the apparatus described or the method of procedure in organizing a County-sponsored unit of this nature will be cheerfully supplied by the writer.

* U. S. Naval Radio Traffic Station, Astoria, Ore.



Call Bootlegging

The use of another man's identity, or call signal in amateur radio, is one of those things that simply is beyond amateur tolerance. We are glad to say that local clubs in practically every case where the club * is on its toes, have worked out a system for running down, warning, and reporting the unlicensed and unqualified operator who is trying to pretend he is a ham, and make use of our ham bands to increase our interference and operating difficulties before he has proved his right.

It is a standing amateur policy to lend the helping hand to the sincere beginner, to start him off right. This does not mean that there is the slightest obligation to tolerate the call bootlegger. To appropriate an identity is a crime punishable by law on conviction. To appropriate or assume a call signal is an offence that the F.C.C. has complete power to suppress. Help yourself to protect your own call and all of our amateur radio structure by turning in to the F.C.C. for action any and all cases of pseudo-amateur activity in any ham band. The one place for complete intolerance in ham radio is, we think, in this matter of spurious use of amateur bands by non-amateurs. The subject is as important on one frequency band as on another, since such activities are easily transferred and copied by other neophytes, or given encouragement by any except prompt firm action. Protect our amateur bands. Keep them for amateurs.

* A.R.R.L. will gladly send a sample affiliated club bulletin to any club requesting information on the system adopted by some of the leading clubs for control of unlicensed operation in their localities.

During a recent trip in Western Pennsylvania, Brad Martin, W3QV, Atlantic Division Director, found himself lost in the suburbs of Pittsburgh while en route to McKeesport. His portable-mobile 56-Mc. rig and W8OTY and W8OC saved the day. These chaps gave QV each street and route direction while he was driving along, and he arrived in McKeesport in good season.

— . . . —

28-Mc. Conditions in Argentina (Via W9ADN and LU7AZ)

Since 28-Mc. activity is at such a low ebb at this time in this country, a report from the Southern Hemisphere may present a different picture than reports from this Hemisphere alone. LU7AZ reports: "During April only signals from North America were heard. U.S.A. signals were good but not as good as during February and March. No signals were heard from Asia, Africa, Europe, New Zealand or Australia. S7 reports came from Europe. Does this mean that only one way propagation was taking place?"

"During May the band was open for the U.S.A. only certain days—from the first to the tenth of May, nothing heard—from the tenth to the twentieth of May, generally open but somewhat uncertain. From the twentieth to the twenty-eighth conditions were curious; one day FB, the next day poor, and the band open only from 5 P.M. to 6:30 P.M. LU time. During May Europe seems FB, coming in again—no VK, ZL, K6, no Africans, no Asians, but heard JNJ harmonic about S9 every night."

— . . . —

On April 28th the Southeast Radio Experimental Association was asked by W6GXM, S.C.M., Los Angeles Section, if it could furnish at least three transmitters and receivers working on 56 Mc. to assist in conveying orders to the various patrol boats and land stations engaged in conducting the Annual Inboard Races under the auspices of the Los Angeles Speedboat Association at Newport Bay, California. The Association did a splendid job with less than one week's notice. Much credit for the excellent service rendered is due Andy Abraham, W6MQS, O.R.S./O.P.S., for his work in quickly organizing the network which handled this event. Due to Andy's efforts, seven transmitters and receivers were procured. W6IGO operated his transmitter at the judges' stand. W6MQS, W6HDV, W6LAK and W6EJZ operated portable-marine, receiving many messages and clearing the courses of small craft and debris. W6NAT operated portable-marine in a runabout equipped with fire-extinguishing equipment. W6HEW operated portable-mobile in a car at the pits where boats were frequently serviced. A total of approximately 200 messages were handled to and from the boats and land stations. The network functioned from 10:30 A.M. to 3:30 P.M. on May 2d.

— . . . —

In line with W1INB's suggestion (June QST) that we sign the abbreviation for our state after our call letters when signing off, W5GIK comes forward to point out that Arkansas hams have done this for years—just listen in, he suggests, and you'll hear "AR K" at the end of most of their transmissions! Hi. And we're reminded of the dilemma of Virginia hams in using the abbreviation for their state—VA. . . Many changed to VIR to avoid confusion with the final sign-off signal VA.

— . . . —

O. B. S.

The following is a supplement to the list of A.R.R.L. Official Broadcasting Stations in October QST (page 122): W1AW, W2JGC, W2JHB, W3FPW, W3GPC, W5DKR, W5FFW, W5FLU, W5FSK, W6IMI, W7EYS, W8PMB, W8PQQ, W9PWU, W9PZU.

QFS

"IT HAS often been my experience after calling CQ to hear several stations reply. How to 'hook' them all has been a problem because as soon as I would call one, the others generally think that they have missed and begin to hunt for some other possible contact. I offer the following as a possible solution, in the hope that it may be the means of fostering more frequent multiple QSO's with their resultant good-fellowship:

"Assume that W3QP calls CQ in the usual way, and hears three other stations answering; W3QP will come back with 'QFS QFS QFS (dash) W2CC W2CC (comma) W1MK W1MK (comma) W6CUU W6CUU de W3QP W3QP (dash) W2CC 7130 kcs W1MK 7135 kcs W6CUU 7120 kcs (dash) GA W2CC others pls QRX for him K.'"

"The use of the QFS seems important to me as a sure way to attract the attention of the second and third stations called to the fact that a multiple QSO is in the making. QFS is suggested from the initial letters of 'Following Stations please QRX for multiple QSO, getting you all OK.' It is needless to point out that the ratio of QRM to Number of Stations working is materially improved as the number of stations per each multiple QSO increases: two stations, 1:2; three stations 1:3, and four stations, 1:4, etc."

— W3QP

— . . . —

There are over 400 licensed amateurs in Seattle, Wash., and its environs. In a gesture of real ham spirit and in an effort to include all active amateurs in their major activities, the progressive Amateur Radio Club of Seattle mails invitations to its hamfests and especially interesting meetings to all the licensed amateurs in the area. This not only makes the affairs extremely successful but it also builds goodwill among all amateurs in and around Seattle. While it's a bit "tough" on the club secretary (hi), it's a very commendable practice.

The Seattle Club has a special red-colored membership card. Around the edge are printed the months of the year, where notations are made as each month's dues are paid. This helps in keeping the dues up to date. The club now has new headquarters in the Seattle Chamber of Commerce, and meets the first and third Tuesdays of each month. The Amateur Radio Club of Seattle was first to instigate the idea of a radio "Field Day," and from that beginning the International and National Field Days developed. 56-mc. "hunts," or "chases" are a regular Seattle activity, several mobile rigs being operated by W7APT, W7BRS, W7DZ, W7AWP, W7GT, W7FEU, W7BBB, W7RT.

— . . . —

During a drive in the Spokane (Wash.) Recruiting District, the fact that recruits were desired for the U. S. Army Air Corps was noted by Lt. E. N. O'Connell, Air Corps Reserves, Kalispell, Mont., who knew of a young man who was anxious to get into the Air Corps. Knowing that the vacancies were few and that recruiting was to stop within a very short time, Lt. O'Connell, a radio amateur himself, turned to ham radio to contact the Recruiting Officer in Spokane. He visited W7BWH, Kalispell, and asked his cooperation in contacting Spokane. W7BWH made contact on 'phone with W7FIT, Spokane. It happened that at the time the message to Major Chaddock, Recruiting Officer, was being sent by W7BWH, W7FLG, owned and operated by Major Chaddock, opened up with a CQ. W7FIT called W7FLG, told him about the message coming from W7BWH, W7FLG tuned to W7BWH, established contact, and a two-way conversation between Lt. Connell and Major Chaddock made it possible for several questions to be answered, resulting in the enlistment of the Kalispell recruit.

— . . . —

56 Mc.

A method of standardizing transmitting and listening schedules for DX on 56 Mc. is suggested by W9FM: As far as possible, every one without a transmitter listen during the first five minutes of each hour. Those with transmitters, send for any two of the five minutes, listening the other

three. If additional times are desired, make the five minutes following the half hour of next importance, and the five minutes after each fifteen minutes, of least importance, relatively, using the same general system as for the first five minutes of each hour.

— —

John Huntoon, W9KJY, and H. Reiss, W9ERS, tied for second place in the Amateur Code Speed Contest held at the Chicago Convention, September 6, 1936, with an official rating of 46 words per minute. W. C. Gross, WSBKM, came in third with 43.4 w.p.m., followed by W9HUM 37.4, W9DXZ 37, W9MKX 33.5, W8SS 33. All these men used "mills" with the exception of W8SS, who copied with a "stick." The excellent record of W9ERU in winning first place with 52.2 w.p.m. is indeed something to shoot at!

— —

Amateur radio made possible the accurate timing of contestants in the 1936 Soap-Box Derby held at Rapid City, S. Dak. The Derby was held outside the city limits where no telephones or other forms of communication were available. Due to curves and hills on the track, the starter was unable to see the timer at the finishing line. The local amateurs took the situation in hand and, by use of 56-mc. transceivers, two-way communication was made available. The amateurs responsible for this work were W9ADJ, W9TOP and Gerald Lee.

— —

"I think Ted Cook, ZT6AQ, should get some credit for about as fine a bit of QSP as ever took place—Van of ZU1T should also get his share. It started with a young lady in distress here needing some dope from her father in South Africa in a big hurry. He was supposed to be in Capetown with the South African Railway, so I hooked ZU1T and told him to go to it—which he did. But the OM was out on the road somewhere near Johannesburg, QTH of ZT6AQ, who had been listening to the whole thing and immediately broke in and offered to locate the OM in Johannesburg; the S.A.R. office there told Ted that the OM had gone to Pretoria. So Ted wired Pretoria and the S.A.R. there said he had already left for Durban! But Ted was only warming up because he shot another wire to Durban, supplementing it with an airmail letter explaining the predicament of the YL. The OM got it all and wired back, but misunderstood the questions the first time and Ted had to write again—after which all was straight and the YL got her dope. All this took four days, but the point is that the YL had cabled her dad several days before she came to amateur radio for help, yet said cable finally reached him after he had all the dope via ZT6AQ! It is stuff like that, that makes a fellow proud to be a ham."

—W6CUH

A.R.R.L. Headquarters Operators

Hal Bubb, "Hal," Chief Opr. W1AW

The following calls and personal sines belong to members of the A.R.R.L. Headquarters gang:

W1AL, J. J. Lamb, "jim"
 W1AW, A.R.R.L. Headquarters Operators Club
 W1BAW, R. B. Beaudin, "rb"
 W1BDI, F. E. Handy, "fb"
 W1CBD, C. B. DeSoto, "dc"
 W1DF, George Grammer, "gz"
 W1EH, K. B. Warner, "ken"
 W1ES, A. A. Hebert, "ah"
 W1GS, F. C. Beekley, "beek"
 W1JBJ, Thomas W. York, "tom"
 W1JEQ, Vernon Chambers, "vc"
 W1JFN, A. L. Budlong, "bud"
 W1JPE, Byron Goodman, "by"
 W1JTD, Hal Bubb, "hal"
 W1SZ, C. C. Rodimon, "rod"
 W1TS, Don Mix, "don"
 W1UE, E. L. Battey, "ev"

Station Activities VANALTA DIVISION

ALBERTA—SCM, Alfred D. Kettenbach, VE4LX—BV will operate portable at summer cottage. BW is celebrating arrival of Junior op. Congratulations, Ted. CX is on 3.9-Mc. 'phone with new rig. EA continues to get fine reports from DX. FR is busy with new 14-Mc. rig. HJ, MR, XF and ADW are heard on 7 Mc. consistently. VJ has directional array for 14 Mc. ZP will operate a VE9 at Cooking Lake this summer. ADW strung new skywire. AGZ is new Edmonton station. KK of Grande Prairie has worked all "W" districts on 1.75-Mc. 'phone. ZW sports a 35-watt carrier on 1.75 Mc. AES, with his Irish brogue, is heard on 1.75-Mc. 'phone. The Northern Alberta Radio Club gets good turn-outs at meetings.

Traffic: VE4GE 28 LQ 12 AFT 9 QK 7 WX 1.

BRITISH COLUMBIA—SCM, D. R. Vaughan-Smith, VE5EP—The B.C.A.R.A. staged a QSO Contest which was well enjoyed by all who participated. EN captured the first prize of a T20, JH snagged the second of a Biley crystal and EH a transmitting dial. The V.S.W.C. has fulfilled its building demolishing contract and is hard at work on new clubhouse. FG still spends 75 per cent of his time handling traffic. RK, a first reporter, is on every day except Sunday from 1 to 2 P.M. OK took a trip on the Anyox. UL visited Vancouver. Rumors are rife regarding DD and BQ assuming added responsibilities. AX took a portable into Northern Alberta to see if the equipment would stand the gaff. It did, and he is now back in town looking for a QSO. EP is almost ready to modulate on 3.9 Mc. with Class B '46's. GF has similar plans. ND schedules his brother EO daily except when the batteries are low at FO. EU at Butedale works into Vancouver on 3.5 and 7 Mc. He edits the *Butedale Bugle*. PJ uses the shield as described in QST à la Faraday. GI keeps constant watch on 28 Mc. with his 100TH. NG plans to get her rig on 14 Mc. and see if she can get out on that band.

Traffic: VE5 RK 1 FG 32 ND-EO 27 EP 16.

PRAIRIE DIVISION

MANITOBA—SCM, A. J. R. Simpson, VE4BG—GC resumed experiments with 56-Mc. mobile rig. AAW reports for Dauphin gang. Working a K6 must have been too much for ACD, as he was found reposing under the operating table the next morning sound asleep. WW and TQ have been quite successful in working DX. The formation of a radio club at Brandon has pepped up amateur activity in this spot. AFY changed his note to a very FB signal. AGR, a new station, has cleaned up his receiver difficulties. AC has a four-band emergency rig all ready to go. HD has a new skyhook. AGM is ex OQ. AG has been building a new super. EK keeps going on 14-Mc. 'phone. GQ has acquired some high-power plate supplies. KX returned from a trip to California. LH is one of the best and busiest 14-Mc. 'phones in Winnipeg. NI is all for getting DB20 for his receiver after borrowing one from ZK for a few days. TO has gone 14-Mc. 'phone. UX is now installed way up North and has been QSO Winnipeg through RO. VI had a scare about his T200, but it turned out to be wrong. LC. RO has been appointed the new QSL Manager for this district, and we all wish him luck and success at it. The M.W.E.A. Bulletin is going over very FB, having been read from coast to coast with only three issues off the press. The editor would appreciate any information suitable for publication. A sample copy will be mailed to all those writing for one. The M.W.E.A. extends an invitation to all to drop in at their club rooms any Thursday at Room 203, Scott Block, Winnipeg. Winnipeg amateurs are pulling off a hamfest on June 26th. Get your portable equipment and appetites in shape for this date.

Traffic: VE4AAW 23.

SASKATCHEWAN—SCM, Wilfred Skaffe, VE4EL—BF has been working 3.5-Mc. 'phone. RB is now located in Prince Albert. WI and TI have gone North to operate Forestry stations. UG is working on the new rig. UH completed his 'phone outfit. PE got going after a long absence. TW erected new skywire to put his signal in Europe. QZ ran up

(Continued on page 68)



CORRESPONDENCE

The Publishers of *QST* assume no responsibility for statements made herein by correspondents

"Constructive Criticism"

Springfield, Ohio

Editor, *QST*:

May you be congratulated on the commendable attitude and intestinal fortitude shown in the last issue (May) of *QST* in verbally spanking those of us who, in not playing the game in all fairness by operating outside the amateur bands as well as the law, bring into disrepute not just one or two unthoughtfuls but the group as a whole.

To many of our minds this seems to be a step in the right direction, and is one of the nicest pieces of constructive criticism I have seen in *QST* for a number of years. It usually smacks of the destructive with the continual harpooning of the Kilowatt, the Fleapower, the Fifty-word-per-minute man, the Lid, and, mostly, *QST*. Let us skip all that and play it as a game, enjoy it as a hobby, forget those petty jealousies. Life is all too short as it is with our allotted three score years and ten without wasting half of it arguing over several schools of thought. It was here before a lot of you were in it and it is going to be here when you're making a feast for the worms.

—Richard C. Littler, *WSJRG*

Contests and Courage

415 North 5th St., Minneapolis, Minn.

Editor, *QST*:

Please accept a metaphorical pat on the back for your stand in regard to disqualification of certain stations in the last DX Contest.

In these times when such sorry efforts have been made to keep the laws, and when everyone is taught that he can play the game without regard for its rules, it is indeed gratifying to find that the A.R.R.L., the governing body of us amateurs, has the courage to continue to stand for the American way.

It probably took a lot of conferring and arguing to decide to do what you did. I admire your guts, and certainly any fair-minded amateur should do the same. You will no doubt receive complaints from a few whiners, but don't let them influence you.

May our League continue in its strength.

—L. A. Morrow, *W9VKF*

More on Flea Power

208 Vliet St., Kewaunee, Wis.

Editor, *QST*:

The boys who are after flea-power allocations on any of the bands are, I believe, barking up the wrong tree. It's a nice thing to wish for, but the idea is too radical and would entail too much policing of the bands to be workable. There always will be some fellows doing a bit of chiseling, and at a distance of 1000 or 500 miles you'd have to do some tall figuring to know whether a station was using more than 25 watts or had a very efficient rig and antenna.

The best way out of the kilowatt QRM problem is, I believe, W3EEW's plan of a WAC certificate for low power. And that, too, would let somebody in for a lot of checking up.

Couldn't we just make a game out of this low-power idea and from time to time print lists of DX worked with small rigs? If I had a kw. I'd be surprised every time I called a DX station and didn't raise him. But all I have is a 6L6 crystal oscillator and it gives me a tremendous thrill to work a KA or similar DX.

Forty-meter crystals are cheap, and by choosing several good spots in doubling to 14 Mc. you can chase DX around in fine style and select a clear channel at will. To me that plan is a lot more fun than setting a kw. at the edge of the band and blasting away like a space gun; or setting a flea-power rig on one frequency and then complaining about the QRM spoiling your DX.

But, whatever we do, let's not rag the high-power boys about being unfair. They're certainly entitled to a kw. if they can finance it. Rather than trying to chase them off of some parts of the bands, let's give 'em the old run-around by showing 'em that we can work choice DX right under their noses.

To this ham it looks as though the QRM problem isn't caused by any one group. The QRM that leaves me tearing my hair is when one of those idiots who hasn't the smallest spark of decency holds his key down for long stretches while tuning his rig. And while *QST* is about printing the calls of the stations that cheated during the recent DX contest, why not police the bands a bit and print the calls of those stations who cause such needless and irritable QRM. That would be doing something.

—C. F. Temby, *W9VOV*

(Continued on page 46)

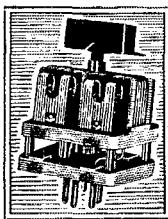

USUALLY on this page we have told about new developments only when they were pretty well worked out, but for once we are going to use this space just to start something. The rough outline of a rather unusual multi-frequency crystal-controlled exciter is given below. For one reason and another we do not feel justified in taking on the development of the unit ourselves at this time. But it does seem like a pretty good idea, and it is the sort of thing that the amateur can develop to per-

fection, so we are passing it on.

Basically the idea consists of using two separate crystal-controlled oscillators at the same time. Their outputs are added and fed through a detector. The sum-frequency component is then picked up and passed on to the buffer or doubler.

This arrangement has a number of advantages. For example, if an X-cut crystal ground to 5.54 MC is used in one oscillator, and a Y-cut crystal ground to 8.50 MC in the other, the sum-frequency component will be 14.04 MC, which is just inside the twenty meter band. Since these two types of crystal have temperature coefficients of opposite sign, the combination can be made to have zero drift if the crystals are carefully matched. Theoretically it can, anyway. However, even taking crystals at random the drift of the combination will probably be as low as that of an A-cut crystal.

By using more than one pair of crystals, a large number of frequencies become available. Thus, suppose that two X-cut crystals ground to 5.58 MC and 5.62 MC and two Y-cut crystals ground to 8.62 MC and 8.74 MC are added to the pair above. The six crystals will then give nine frequencies spaced 40 KC apart, covering the twenty meter band. Similarly, a total of ten crystals would give twenty-five frequencies.

As a matter of fact, there are actually many more different frequencies than this present. In addition to the fundamental and harmonic frequencies of the single crystals, there are the difference-frequencies of the pairs, which also have harmonics. These many spurious frequencies probably present the greatest problem that will have to be met in the design of the unit. With the particular crystal frequencies given above, the fifth harmonics of the difference-frequencies will fall in the range between 14.4 and 16 MC, which is bad as it is just outside the twenty meter band. However, being fifth harmonics, they should not be strong enough to give much trouble. None of the other spurious frequencies are nearer than 2.4 MC.

The power output available will undoubtedly depend a great deal upon the method used to combine the oscillator outputs. If the two outputs are merely mixed, the resulting signal is not likely to be very powerful. But if the two frequencies are really added (as by using two pick-up coils in series) the net output should be very nearly the sum of the outputs of the two individual oscillators. This can be fed directly into the grids of a Class C amplifier, of course, since the latter will supply the necessary detector action.

JAMES MILLEN





Grand Island QSLs

Q S L and S W L cards—except those issued by the Government for violation of the rules and regulations of the F. C. C.—are the joy of every ham.

Be sure that your carrier is free from hum. Use Mallory HD (Heavy Duty) or Mallory HS (High Surge) Condensers for filtering the power supplies of your oscillator and low-powered buffer-doubler stages—the place where hum usually starts.

Available in both carton and aluminum can types as follows:

Cat. No.	Cap.	D. C. Wkg. Voltage	Container	List Price
HD680	4 mfd.	500	Carton	\$1.20
HD681	4 mfd.	500	Round Can	1.45
HD682	8 mfd.	500	Carton	1.50
HD683	8 mfd.	500	Round Can	1.75

Recommended for use where the momentary surge voltage does not exceed 585:

HS690	4 mfd.	600	Carton	\$1.75
HS691	4 mfd.	600	Round Can	1.85
HS692	8 mfd.	600	Carton	2.45
HS693	8 mfd.	600	Round Can	2.60

Mallory HS (High Surge) Condensers have been successfully used in power packs with momentary surges as high as 800 volts.

See these new condensers at your nearest Mallory-Yaxley Distributor's.

P. R. MALLORY & CO., Inc.
INDIANAPOLIS INDIANA

Cable Address—PELMALLO



Correspondence Department

(Continued from page 44)

920 Alpha St., Inglewood, Calif.

Editor, QST:

... I suggest that the A.R.R.L. petition the F.C.C. for permission for amateur stations using 50 watts input or less to employ smooth R.A.C. notes.

I believe that such a practice would lessen the interference within our bands because of the property of the ear to separate sounds of different pitch even though they be on the same radio-frequency. Also most interference from low-powered stations comes, not from broad waves, but from keyclicks caused by breaking the high voltage, and with R.A.C. permissible these stations could use primary keying without "tails." . . .

—Geo. Dery, W6HG

325 Winslow St., Watertown, N. Y.

Editor, QST:

A swell idea, this flea-power section in our bands, but I don't believe it is quite practical—especially from a legal standpoint.

However, if a week could be run off as "Flea-Power Week" and limit power input to 25 watts one week, later cut it to 20 watts, then in a few more months to 15—when we're down to 5 watts we'll be doing something.

One of us using under 25 watts (or whatever the figure is) could call "CQ FP" and expect no calls from stations using over the power limit for that week.

Without any special effort I have accomplished the following miles per possible watt output:

Band	'Phone	C.W.
5	70 mi.	—
10	400 mi.	1250 mi.
20	—	250 mi.
40	—	—
80	—	50 mi.
160	10 mi.	25 mi.

Hundreds have done much better than this—thousands haven't tried!

I've worked several stations whose signal report was about the same as mine—and started bringing in the fact that I was using low power, only to be dug with something like this " . . . FB OB but ur still using three times mi 2 watts . . . !"

With low power we'll learn how to call and break in, how to get efficiency, why we should use the same antenna to send and receive—and how to reduce QRM and BCL trouble. . . .

—George A. Bonadio, W8OMM

1317 Pearl St., Columbus, Ind.

Editor, QST:

... All of us little fellows would have a kw. rig if we could afford it. But if everyone had a kw. conditions would be a lot worse for everyone than they are now. I wonder if these fellows with high-power, who say they went to high-power just to overcome the QRM, ever happened to think that the QRM that they are overcoming is about a dozen "little fellows" who enjoy a good QSO just as well as anyone, but just have to pull the switch and go to bed when a kw. rig lands on or near theirs. . . .

—Carlos Vail, Jr., W9MUR

Royal Canadian Mounted Police

"E" Division, Vancouver, B. C., Canada

Editor, QST:

... Concerning the range of the low-power station, I have had very good success with as low power as 5 watts into a '45 TNT, even in the evening hours, working as far east as Minnesota on 80 meters. Also I really believe a person does get a lot more thrill out of working these distances on low power.

Again, considering the efficiency and stability of a rig working away below its rating, there would be a lot better quality signals on the air.

—W. E. Marshall, VE5PZ

THEY'LL STAND the OVERLOADS!

No Breakdowns or "Opens"

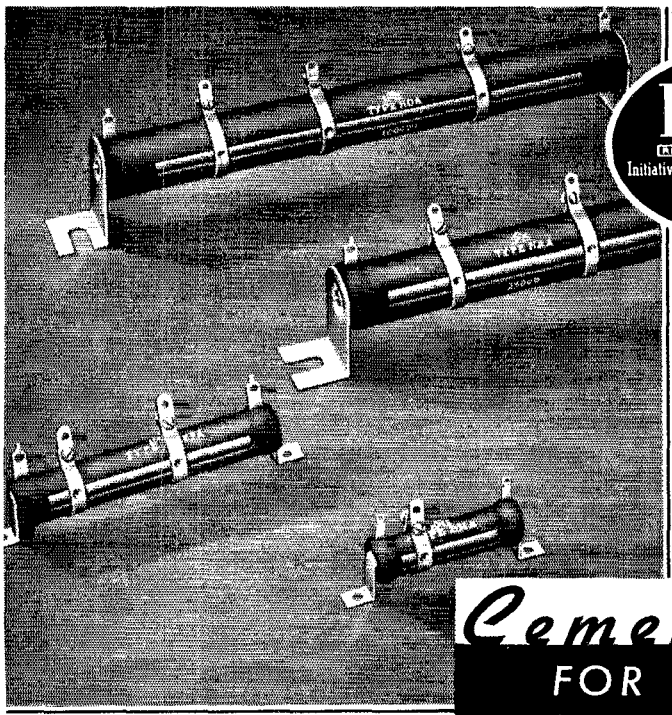

TRANSMITTING POWER WIRE WOUNDS

Cement Coated
FOR DURABILITY

IRC Power Wire Wound Resistors are built to give *balanced* performance in every characteristic. They dissipate heat rapidly; are built to stand heavy overloads, moisture—even salt water immersion—and have the added advantage of extreme mechanical strength to guard against breakage. Throughout the world, you'll find them specified for the most exacting industrial, aircraft, broadcasting, naval and commercial communications applications. . . . Made in a complete line of fixed and adjustable types for every need. Write for IRC Resistor Catalog No. 41.

Dozens of Uses for these "10-WATTERS"

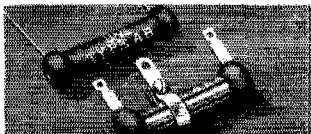

. . . Just the thing to complete a hurry-up service job or whenever you do not have the exact needed range in $\frac{1}{2}$, 1- or 2-watt resistors. By moving the contact band of the adjustable unit, any range up to the maximum value may be obtained.

TYPE ABA—10 Watt Adjustable—**List 60c each**
TYPE AB—10 Watt Fixed—**List 40c each**. Made in all practical ranges from 1 ohm to 25,000 ohms inclusive.

INTERNATIONAL RESISTANCE COMPANY

401 NORTH BROAD STREET, PHILADELPHIA, PA.

Factories or Licensees in Canada, England, France, Germany, Italy, Denmark and Australia

MAKERS OF RESISTANCE UNITS OF MORE TYPES, IN MORE SHAPES, FOR
MORE APPLICATIONS THAN ANY OTHER MANUFACTURER IN THE WORLD

1937 EDITION

The radio amateur's handbook

THE STANDARD MANUAL OF AMATEUR RADIO COMMUNICATIONS



PUBLISHED BY THE AMERICAN RADIO RELAY LEAGUE

SPECIAL

JULY AND

Membership
A Year
and the Radio

• ALL FOR
(FOREIGN

QST and the Handbook — the basis of every radio amateur's library! The Handbook offers you in its four hundred pages, the permanent information which radio amateurs need — fundamentals, history, constructional data for transmitters, receivers, power supplies, antennas, measuring equipment, everything. QST brings you up-to-date each month with the latest dope on this and that, new developments in circuits and equip-



OFFER

AUGUST ONLY

in the A.R.R.L.,
of QST
Amateur's Handbook

ONLY \$3.00 .
(\$3.75)

ment, and the thrilling, running story of moment-to-moment Amateur Radio. If your QST subscription has several months to run, take advantage of this bargain anyhow — we'll extend your membership and subscription twelve months from its present expiration. Note that this offer applies only if your order is sent direct to A.R.R.L. This special rate, in effect during July and August only, is \$3.00 in U. S. A., proper, \$3.25 in Canada and \$3.75 elsewhere.

QST

1960, 1967
SECURE

Amateur Radio



Say You Saw It in QST — It Identifies You and Helps QST

It's the TOP!

..for amateurs interested
in ultra-high frequencies

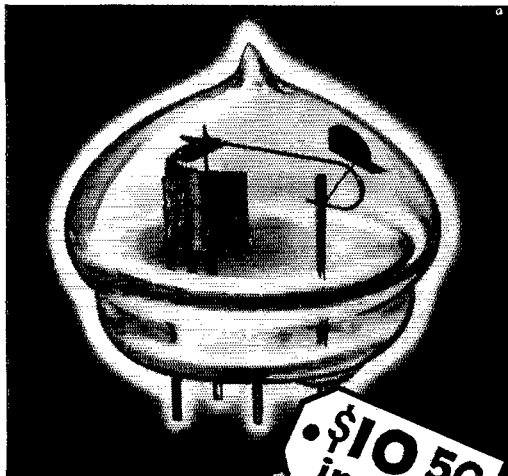

316 A
delivers 7.5 Watts
at 500 Mc.

Western Electric's 316A triode has won tremendous popularity with amateurs. Many ultra-high transmitters have been built around it.

Designed specially for use in oscillator circuits of the negative grid type at frequencies up to 750 mc., it delivers 7.5 watts at 500 mc.

Important features producing higher efficiency are: absence of conventional glass press; close electrode spacings, with consequent reduction of electron transit time; short, heavy leads; low interelectrode capacities.

Upper frequency limit.....	750 mc.
Nominal power at 500 mc.....	7.5 watts
Maximum plate voltage.....	450 volts
Maximum plate dissipation.....	30 watts
Maximum plate current.....	80 Ma.
Filament voltage.....	2 volts
Filament current.....	3.65 amps.

The booklet packed with each 316A gives typical oscillator circuit details and complete operating instructions. For full details: Graybar Electric Co., Graybar Building, New York.

Western Electric
BROADCASTING EQUIPMENT
Distributed by **GRAYBAR Electric Company**

What the League Is Doing

(Continued from page 22)

56 to 60 Mc. jointly to amateurs and experimental and would make a new such joint assignment from 120 to 130 Mc.

No. 45, Belgium:

"Suppress the so-called sharing of the band of 1715 to 2000 kc. with amateurs. Reasons: Imperative necessity of protecting the fixed and mobile services, notably the maritime mobile A-3 service; experience shows that amateurs possess over-abundant bands for their communications for short as well as for long distances."

Re Shortwave Broadcasting:

Several administrations point out the need for increasing the allocations given shortwave broadcasting, but without suggesting any specific figures. U.I.R. proposes widening their present bands, without affecting us.

No. 83, Japan:

Replace the language of the first paragraph of Section 5 of Article 8, now providing that the power of amateur stations may be fixed by each administration, with the following language: "The maximum power that private experimental stations may use shall be fixed by the interested administrations, taking account of the technical qualifications of the operators and the conditions under which the said stations must work. As to amateur stations, this power shall not exceed 50 watts measured at the input to the antenna." "Reasons: To reduce interference."

No. 191, Hungary:

Add the following text to the provision in Article 14 that each country notifies the bureau of the Union of the calls assigned to its stations: "This notification does not apply to calls assigned to private experimental stations, amateur stations and private radio communication stations." As an argument it is stated that these data are not used by the bureau and do not occur in any of its publications, since the regulations contain no provision to that effect.

Nos. 225, 298, 409 and 423, Netherlands Indies:

The Netherlands Indies propose the abandonment of CQ calls not followed by a K as a means for sending broadcasts, and the readoption of the old symbol QST for that purpose.

No. 245, Finland, Norway, Sweden:

In Article 19, on the employment of waves in the mobile service, add the following new paragraph: "The wave of 1650 kc. is the international calling wave to be employed by the mobile radiotelephony service in the band 1560-3605 kc. It may only be used for calling and replying, for distress traffic and for signals and messages of urgency and of security." See previous proposal above by these countries.

No. 246, Iceland:

A similar addition: "The wave of 1650 kc. is the international calling wave to be employed for the mobile radiotelephony service in the bands authorized between 1500 and 4280 kc. It may only be used for calling and replying, for distress traffic and for signals and messages of urgency and of security." See previous proposal by Iceland.

No. 262, Finland, Norway, Sweden:

Another proposal for a new paragraph to go into Article 19, again making mention of "authorized wave bands between 1560 and 3605 kc."

No. 263, Iceland:

Ditto, except making mention of "authorized bands between 1500 and 4280 kc." See above.

No. 276, Great Britain:

In Article 20, Section 6, paragraph 2, providing that any station making emissions for tests, adjustments or experiment must transmit its call at frequent intervals in the course of its emissions, introduce after the word "transmit" the words "at as slow a speed as possible." "Reasons: For more easily identifying an interfering station."

No. 367a, Germany:

In Article 29, providing for the low-power mobile radiotelephony service, replace the indication 1530 to 2000 kc. by 1530 to 3515 kc. "Reasons: The service of mobile sta-

**"I've USED
CENTRALAB
SINCE THE
PIONEER
DAYS"**

Says Mr. F. D. Wardner
Wardner Electric Co.
St. Paul, Minn.

Thanks, Mr. Wardner, and because we understand that you are one of the outstanding service men in the Northwest, we are doubly proud of your faith and confidence in Centralab.

Yes — since the very beginning Centralab has been building a *Quality* control.

Servicemen everywhere are following Mr. Wardner's plan . . . by staying with Centralab for All replacements . . . You can do a better service job with Centralab controls . . . so consult your jobber and get new 1937 CENTRALAB Volume Control Guide from him . . . free!

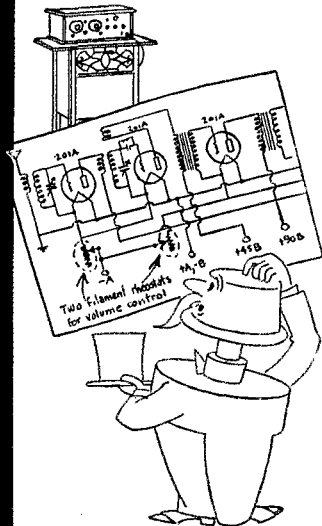

Remember—

when diagrams like these were all the vogue . . . and *Centralab Controls* were among the few "dependable" units?

Centralab
RADIO H M

MILWAUKEE
WISCONSIN

Division of
GLOBE-UNION INC.

BRITISH CENTRALAB, LTD.

Canterbury Road, Kilburn, London, N.W. 6, England

FRENCH CENTRALAB CO.

118 Avenue Ledru-Rollin, Paris XI, France

More Distance Per Watt WITH TRIPLET MODULATION MONITOR

MODEL
1295

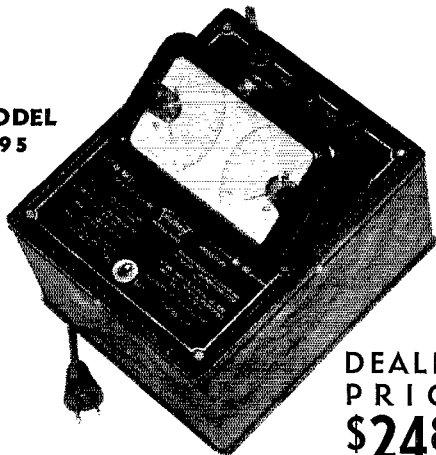

DEALER
PRICE
\$2483

For All Voice Transmitting Stations

Model 1295 Modulation Monitor enables you to tune your transmitter to maximum efficiency thereby saving the power loss of under-modulation. Result — clearer signal to distant stations.

Shows actual modulation percentage from 40 to 120 percent.

Eliminates the uncertainty of depending on the ear, variation of antenna ammeter or the loop and light in determining carrier shift and percentage of modulation. Actual modulation percentage is shown on direct reading Triplet Twin Precision Instrument. Factory calibrated and no further calibration needed.

SEE YOUR JOBBER — WRITE FOR CATALOG

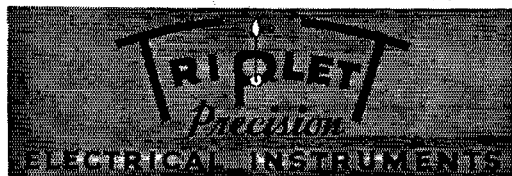

The Triplet Electrical Instrument Company
257 Harmon Avenue, Bluffton, Ohio

Without obligation please send me more information on
Model 1295 Modulation Monitor. I am also interested

in

Name

Address

City State

tions of this category has been operating some years on the band 1530-3515 kc. It exists by virtue of the special arrangements concluded between the European administrations. (Regional arrangement for radiotelephone service in the North Sea, Lisbon 1934, and regional agreement for radiotelephone service in the Baltic Sea, Stockholm 1935.) The widening results from the increase in the radiotelephone traffic in the mobile service."

No. 353, Belgium:

Belgium, without specifying figures, calls for widening to correspond to the regional arrangements of the North and Baltic Seas.

No. 359, Finland, Norway, Sweden:

Modify the figures in Article 29 to read "within the band 1560-3605 kc."

No. 360, Iceland:

Modify the figures in Article 29 to read "within the authorized bands between 1500 and 4280 kc."

Nos. 362, 363, 365, 366 and 367:

Here occur further reference to minor modifications of Article 29 in which the same editing of the language is proposed, Finland, Norway and Sweden referring to the single band 1560-3605; Belgium citing no figures; Iceland referring to authorized bands between 1500 and 4208 kc.

No. 382, Italy:

Italy proposes a complete new draft for Article 31, controlling the formation and operation of the C.C.I.R. Her draft omits all mention of the admission and participation of international organizations such as the I.A.R.U., of which five are presently admitted. The old language, now omitted, was: "There are also admitted international organizations interested in radio-electric studies which have been designated by the previous plenipotentiary or administrative conference, and which engage themselves to contribute to the cost of the meetings as indicated in the preceding paragraph." The old language also provided that, in principle, the meetings of the C.C.I.R. would be held every five years; Italy proposes that this now be changed to every three years, according with recent practice.

"Limit to 100 kc. the width of the band now 3500 to 4000 kc., i.e. 500 kc., in which amateurs may transmit. Reasons: Very great need of the public service; progress in stabilization technique which easily permits the reduction of the band used by amateurs. In Belgium amateurs are only authorized to use a band of 70 kc. (including tolerances) and this situation constitutes no hardship for them."

"In the band of 14,000 to 14,400 kc., i.e. 400 kc., exclusively reserved in the Madrid table for amateurs, reduce the amateur band to 200 kc. Reasons: Shortage of frequencies for official services; technical progress in the stabilization of amateur transmitters which easily permits reducing this band without inconvenience."

No. 46, Canada:

In partitioning the ultra-high frequencies between 30 and 100 megacycles, Canada proposes that the assignment 56-60 Mc., now joint to amateurs and experiments, be changed to read exclusively amateurs.

No. 48, Finland, Norway, Sweden:

"Modify as follows the assignment of frequencies: The bands of frequencies 1560-2785 kc., 2310-2900 kc. and 2930-3605 kc. shall be assigned to the mobile service, A-1, A-2 and A-3. The frequency of 1650 kc., with a guard band 1630-1670 kc., shall be reserved, as a calling wave and a distress wave, to radiotelephone service with ship stations and airplanes. The bands of frequencies 1530-1560 kc. and 2900-2930 kc. shall be assigned to radio beacons. The bands of frequencies 2785-2810 kc. and 3605-3635 kc. shall be allocated to airplanes."

Follows a long argument about the particular needs of the North Sea and Baltic regions, with reference to a conference held at Stockholm in 1935.

No. 49, France:

France refers to the 1.75-Mc. amateur band which in the European regime is assigned in two parts: 1715-1925 to amateurs, fixed and mobile; 1925-2000 kc. to amateurs and maritime mobile telephony only. France now proposes the "provision within this band of the following new as-

Every Amateur Station Can Use These RCA Types to Great Advantage

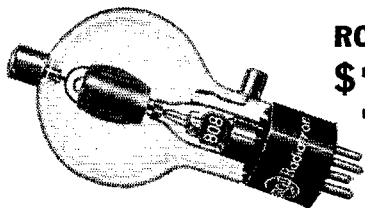

RCA-808

\$10

The RCA-808 offers you many outstanding features—check them off below. The RCA-808 is excellent as a medium-power final stage or high-power buffer doubler.

1. **TANTALUM PLATE**...Gives high plate dissipation and assures freedom from gas.
2. **LEADS**...Plate at top, grid at side, provide maximum insulation, maximum convenience of circuit arrangement, and low inter-electrode capacitances.
3. **BULB STYLE**...Gives maximum heat dissipating area and cooler bulb for equivalent size tube. Large spacing between plate and bulb reduces possibility of gas evolution from bulb.
4. **ELECTRODE SUPPORTS**...Constructed with minimum of insulating materials.
5. **LARGE PLATE CAP**...Provides low contact resistance and greater strength.
6. **HIGH PERVEANCE**...Perveance is a fundamental tube constant inversely proportional to tube impedance. A high-perveance tube is, therefore, a low-impedance tube. A high-perveance tube can be operated at reasonable plate voltages with high plate efficiencies, thus avoiding the necessity for costly high-voltage power supplies.
7. **HIGH-MU GRID**...Requires less bias—is economical and convenient. Low cut-off voltage means low plate current at zero bias; thus, the tube is protected should excitation fail with grid-leak bias.
8. **HEAVY DUTY FILAMENT**...7.5 volt, 4 amp. filament provides large reserve emission for heavy-duty operation.



RCA-913

NOW \$5

The demand for the RCA-913 has resulted in increased production, which permits a saving in costs. Hence, a price reduction. At its new low price of \$5.00, the RCA-913 is now a greater value.

The RCA-913 is *the* cathode-ray tube for use where a larger tube would be unsuitable. Its convenient size plus the fact that it requires only a simple power supply (operates at a maximum of 500 volts and gives good images at voltages as low as 250) makes it particularly suitable for portable equipment, and a highly desirable unit to be built permanently into the transmitter for checking operation and for modulation monitoring.

9. **CONSERVATIVE RATINGS**...Class C telegraph service; 50 watts plate dissipation, 1500 plate volts, 200 watts input power—RCA's conservative ratings assure long, economical, and satisfactory tube operation.



for Amateur Radio

AMATEUR RADIO SECTION

RCA Manufacturing Co., Inc., Camden, N. J. • A Service of the Radio Corporation of America

Say You Saw It in QST — It Identifies You and Helps QST

*You've got what it takes
to be a Speedy Operator!*



ALL YOU NEED IS CANDLER TRAINING

Look what the World's Champion Radio Operator Says about Learning Code RIGHT, and acquiring Skill —

"Practice alone, with any kind of *practice set*, will not develop a skilled operator. It takes a thorough knowledge of the Fundamentals and Mind Training taught exclusively by the Candler System."

Right now you have the capacity of sending and receiving code as easily as you talk and listen. Walter Candler knows how to develop your *sound consciousness* so that your sending and receiving senses will work *automatically*.

You will be amazed at your progress with CANDLER instruction! CANDLER methods are so easy, so interesting — that code skill will just come to you *naturally*. Almost before you realize it, you will be "pounding brass" with the best of them, and taking it as fast as they can send it!

Get the same training that made T. R. McElroy world champion — the same code instruction they give at Harvard University — the same system used by the speedy amateur and commercial operators the world over. It's so easy a nine year old girl won the Class "E" receiving championship of the world two months after learning the Candler way. She could easily copy 30 words per minute on her typewriter. Successful Candler students range in age from 8 to 70 years.

The only difference between you and a skilled radio operator is the coupon below. Mail it today. Walter Candler, maker of champions, will do the rest! Save time and money by learning code and acquiring skill *the Candler way!*

CANDLER SYSTEM CO.

Dept. Q-7 ASHEVILLE, NO. CAROLINA

MAIL THIS COUPON TODAY!

CANDLER SYSTEM CO.

Dept. Q-7, Asheville, North Carolina, U. S. A.

Send at once the BOOK OF FACTS. This does not obligate me.

NAME

ADDRESS

CITY..... STATE.....

CODE SPEED (if any).....wpm.

assignment: 1800-1820 kc., aeronautics. Reasons: The aeronautical services cannot in all cases observe the tolerances imposed on the mobile services and, on the other hand, the power of aircraft stations is always inferior to that of the stations of other services, it is very difficult to protect them against interference if exclusive bands are not assigned them."

"1840-1860 kc., meteorological soundings." Follows an explanation of the method developed by one Professor Molchanoff, involving small free balloons ascending to a height of 30,000 metres and carrying a small transmitter.

Present provision: "7000-7300 kc., amateurs; 7300-8200 kc., fixed. Modify as follows: 7000-7500 kc., amateurs; 7500-8200 kc., fixed. Reasons: By reason of an appreciable increase in the number of amateurs who use this band."

No. 50, Great Britain:

"The administration of Great Britain is of the view that an enlargement of some of the frequency bands between 6000 and 21,550 kc. now assigned to broadcasting ought to be made. She suggests in passing that an additional assignment (perhaps in the shared bands) of about 50 kc. between 3500 and 4500 kc. could be made to the profit of the broadcasting service for occasional needs of a special character."

Great Britain recommends the exclusive assignment to the aeronautical services of a number of bands of frequencies. Included in these is the band 1810-1830 kc., concerning which she says: "In the North Sea regional arrangement, this band was reserved exclusively to touring aircraft. Under the Baltic Sea regional agreement it has been assigned to the coastal stations of Poland but it will perhaps be possible for these stations to be put in a band in the vicinity of 1785 to 1810 kc. which is not now in use."

No. 52, Irish Free State:

Seventeen bands of frequencies are proposed for the exclusive use of the aeronautical services. Included in them are the frequencies 1800-1820 kc.

No. 53, Iceland:

"Modify as follows the assignment of frequencies:

- 1500-1560 kc.—Mobile A1, A2, A3
- 1560-1590 kc.—Radio beacons and fixed
- 1590-1630 kc.—Interior services, A3
- 1630-1670 kc.—Calling wave
- 1670-1715 kc.—Interior services, A3
- 1715-2000 kc.—Mobile A1, A2, A3
- 2500-2710 kc.—Fixed, A3
- 2710-4280 kc.—Mobile A1, A2, A3
- 4280-5500 kc.—Fixed A1, A2, A3

"Reasons: The constantly increasing use of the band 1500-5550 has caused considerable interference between the different services. These frequencies are used as well by small fixed stations and small mobile stations (2 to 4 watts) as by land and mobile stations of greater power (50 to 100 watts) without any subdivision of the band between them. In consequence, the small interior fixed and mobile stations experience intolerable interference from more powerful foreign mobile stations which work on the same frequency. For the purpose of improving this state of things it is proposed to divide the band between the different services, that is to say between the mobile service, radio beacons, the fixed service and the interior service."

No. 54, Italy:

The band 1715-2000 kc. in the Madrid table is assigned on two bases, one basis for the European region and the other for other regions. Italy proposes no changes in the column for "other regions" but as to the European region she would change this assignment as follows: 1715-1800 and 1820-1925, jointly to amateurs, fixed and mobile. 1800-1820 kc., only to aeronautics. 1925-2000 kc., jointly to amateurs and mobile A3.

Carrying this same idea now to higher frequencies, where it has not previously been employed, Italy proposes maintaining the band 7000-7300 kc. for amateurs in "other regions" but making a new assignment in the European region: 7000-7100, fixed. 7100-7200, broadcasting. 7200-7300, amateurs.

Extending the same idea to the 14-Mc. band, Italy would preserve the exclusive assignment to amateurs in "other regions" but in the European regions would have it read as follows: 14,000-14,150, fixed. 14,150-14,300, broadcasting. 14,300-14,400, amateurs.

Concerning the bands 30-56 Mc. and 56-60 Mc., "The

NEW THORDARSON NEW

Multi  Match

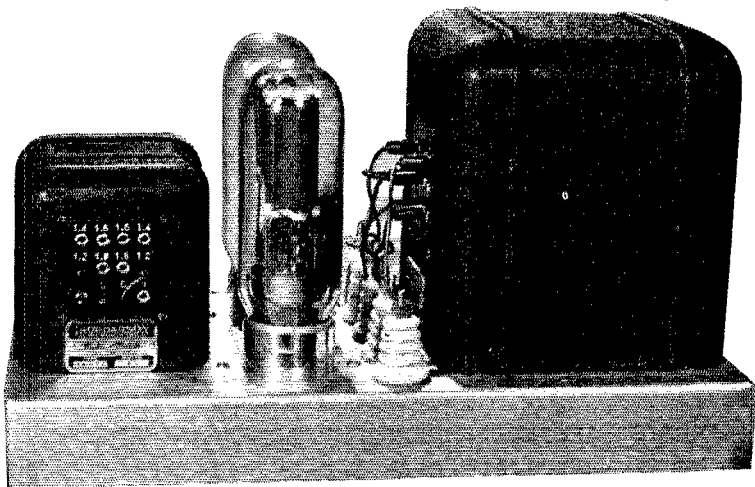

A MATCHING TEAM

*With Plug-in Jack Terminals—Recessed Sub-base Leads
Match Driver and Modulator Stages Instantly*

DRIVER TRANSFORMERS

Correct turns ratio for maximum audio power and minimum distortion. Permits most efficient driver tube operation. Plug-in jack terminals connected to recessed base lugs. Single hole wiring—Completely compound filled—Low leakage reactance—Six types 15 and 30 watt capacities.

MODULATION TRANSFORMERS

Match any tube to any load instantly, with plug-in jack terminals—convenient, easy, practical. Eliminate soldering and binding post connections. Moisture proofed—Double varnished and baked—Completely compound filled—Furnished in five sizes 40 to 500 watts.



FREE

*Ask your parts dealer or write
Dept. Q77 for Bulletin SD296*

FREE



THORDARSON ELECTRIC MFG. CO.

500 W. HURON ST., CHICAGO, ILL.

Demand "Power by Thordarson"

Now—a high-powered—

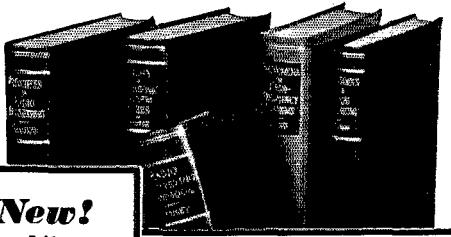

New!

The Library now comprises a revised selection of books culled from latest McGraw-Hill publications in the radio field.

**RADIO
ENGINEERING
LIBRARY**

—especially selected by radio specialists of McGraw-Hill publications

— to give most complete, dependable coverage of facts needed by all whose fields are grounded on radio fundamentals

— available at a special price and terms

These books cover circuit phenomena, tube theory, networks, measurements, and other subjects—give specialized treatment of all fields of practical design and application. They are books of recognized position in the literature—books you will refer to and be referred to often. If you are a researcher or experimenter—if your interest in radio is deep-set and based on a real desire to go further in this field—you want these books for the help they give in hundreds of problems throughout the whole field of radio engineering.

5 volumes, 3064 pages, 2000 illustrations

1. Glasgow's **PRINCIPLES OF RADIO ENGINEERING**
2. Terman's **MEASUREMENTS IN RADIO ENGINEERING**
3. Chaffee's **THEORY OF THERMIONIC VACUUM TUBES**
4. Hund's **PHENOMENA IN HIGH-FREQUENCY SYSTEMS**
5. Henney's **RADIO ENGINEERING HANDBOOK**

Special Low Price and Easy Terms

Bought singly, the five volumes comprising this library would cost you \$25.00. Under this offer you save \$1.50 and, in addition, have the privilege of paying in easy installments beginning with \$2.50, 10 days after receipt of the books, and \$3.00 monthly thereafter. Already these books are recognized as standard works that you are bound to require sooner or later. Take advantage of these convenient terms to add them to your library now.

SEND THIS ON-APPROVAL COUPON

McGraw-Hill Book Co., Inc.
330 W. 42nd St., New York, N. Y.

Send me Radio Engineering Library, 5 vols., for 10 days' examination on approval. In 10 days I will send \$2.50, plus few cents postage, and \$3.00 monthly till \$23.50 is paid, or return books postpaid. (We pay postage on orders accompanied by remittance of first installment.)

Name

Address

City and State

Position

Company QST-7-37

(Books sent on approval in U. S. and Canada only.)

Italian administration reserves the right of presenting at Cairo some proposals relative to the assignment of these bands also to the fixed, mobile, aeronautical and broadcasting services."

**The See-Saw Noise
Silencer**

(Continued from page 14)

placed on its cathode by means of the potentiometer R_3 . Then if the grid of the 6C5 is biased negatively as the signal strength, or the voltage across R_5 , increases the circuit will operate automatically. This is true only if the negative bias on the grid increases in proper relation to the increase in signal input to the detector. Automatic operation with inputs varying from 10 to 15 microvolts to 100 millivolts is possible with this circuit. The low impedance a.v.c. circuit contributes greatly to this fine performance. The 6F6 a.v.c. tube has a grounded cathode. Its grid, with no signal input, is biased negatively by means of control R_7 , which also biases the entire detector circuit below ground at the same time. This bias should be about 30 volts. Then as the grid of the 6F6 goes in a positive direction it draws an increasing amount of plate current. The voltage drop across resistors R_1 , R_2 , R_3 , is arranged so that with no signal voltage the a.v.c. tap between R_2 and R_3 assumes chassis or ground potential.

This point then goes in a negative direction when the drop across R_1 increases, due to the increase in plate current, thus providing negative bias. The common coupling circuit for the i.f. grid returns is then in the neighborhood of 15,000 ohms with a 0.5- μ fd. by-pass. This permits the use of decoupling filters as small as 3,000 ohms and 0.01- μ fd. condensers, a considerable improvement over the conventional values employed. The negative bias for the control grid of the 6C5 is also secured from this same source after suitable filtration the R_4 - C_5 network. The size of resistor R_6 may require some change in value for best results. Also, the leakage diode connected across the load resistor is not always necessary, although it sometimes provides improved performance with a particular type of noise.

One of the requirements of this circuit arrangement is the necessity of securing a sizable below-ground potential. The resistor R_{10} will vary in value depending on the number of tubes used in the receiver. As this resistor handles all the plate current drawn it should be of the twenty-five watt size for safety. If the total plate and bleeder current to be drawn is known, the value of resistance necessary to produce a 50-volt drop may readily be calculated by Ohm's Law. In this arrangement fixed bias Class-AB stages should be avoided, as their varying plate current will cause a shift in drop across R_{10} that may be quite severe at high audio levels. The use of 6L6 tubes with self bias is recommended if high audio output is desired. For telegraph operation, the a.v.c. supply is shorted by the switch SW so that only the fixed bias remains on the control grid of the 6C5. This makes a gate with a fixed setting so that it is

Announcing

TWO NEW

ZERO BIAS TUBES

TZ20 203Z
\$2.45 \$8.50

Another great forward stride for Taylor Tubes. Here are two new tubes that are sure to lead the way in Class "B" usage. Designed for maximum performance at value plus prices, the 203Z and TZ20 have been added to Taylor Tubes mighty sales champion line. Amateurs!! Now more than ever you can build 100% Taylor Tube equipped rigs. Insist on "More Watts Per Dollar!!" Full details and prices on these new tubes are given in Taylor Tubes new FREE 1937 Catalog and Manual which is now ready.

NEW TAYLOR MANUAL READY

Contains—Technical articles—Circuit diagrams—Suggested "Rig" layouts for all bands and power—L/C charts—Page on page of vital important information which you can use and need. Entirely new throughout! Absolutely not a reprint of the now famous first edition. Every amateur and radio engineer must have this fine new manual and catalog to keep up to the minute. Don't waste a second—get your copy NOW. It's big— It's FREE.

FREE—Write us or see your distributor—FREE

"More Watts Per Dollar"

Taylor HEAVY **CUSTOM BUILT** DUTY **Tubes**

TAYLOR TUBES, INC., 2341 WABANSIA AVE., CHICAGO, ILLINOIS

JOB **for** **HAMS**

This is a bonafide advertisement directed to the attention of amateur and commercial radio operators willing to undergo intensive training that prepares for Airline Radio Operators jobs.

TWA Radio Room, Municipal Airport, Kansas City, Mo. One of many radio stations operated by this coast to coast airline.

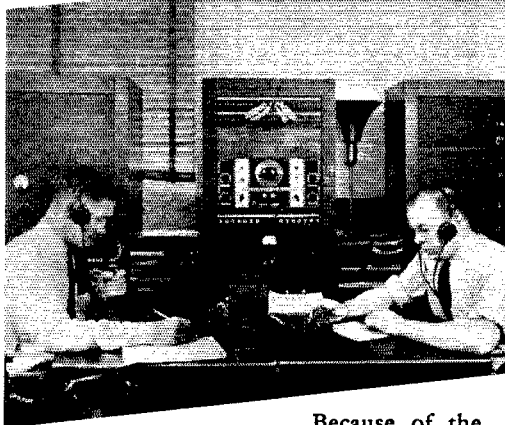

Because of the actual shortage of qualified radio operators thoroughly versed in Airline operating procedure and other important and necessary subjects, we have, with the cooperation of Airlines developed a highly specialized and intensive course of instruction. Training is provided under the supervision of two thoroughly experienced Airline radio operators. We are receiving many more requests for operators than we are able to supply AND THERE IS EVERY INDICATION THAT THIS DEMAND WILL INCREASE MATERIALLY IN THE FUTURE. WE HAVE DEFINITE ARRANGEMENTS WITH TWO LINES TO PROVIDE THEM WITH OPERATORS.

If you are between the ages of 18 and 30, have a high school education, no physical defects and really like radio operating, it will be to your advantage to investigate this unusual opportunity immediately. **WE WELCOME STRICT INVESTIGATION.** Write or wire for complete information.

NORM G. SOUTHER
MIDLAND TELEVISION, INC.
(Midland Broadcasting Company Affiliate)
29th FLOOR POWER & LIGHT BUILDING
KANSAS CITY, MISSOURI

necessary to adjust the receiver sensitivity by means of an r.f. gain control so that the signal "fits the gate". Injection of the beat oscillator on the suppressor grid of the last i.f. stage is recommended. Care should be taken that the input of the oscillator to the suppressor is not excessive, otherwise loss of output and a high hiss level will result.

Now let us go over the basic requirements that must be taken care of if a receiver is to be successfully "noise-proofed," and which at the same time are necessary for optimum receiver performance. A power supply having good regulation, with an electrostatic shield between the primary of the power transformer and the other windings, is necessary. The shield helps materially in preventing or limiting any noise that tries to enter the receiver via the connection to the power source. Despite this precaution in severe noise fields, it is possible to get a substantial noise input which may be picked up in the r.f. tubes (where it can be handled by the silencer), or it may be picked up on audio grid leads and then rectified and amplified. Naturally if this takes place the best silencer in the world will do no good so far as such noise pick up is concerned. The best answer to this problem is the use of a transformer-coupled audio system. In a resistance-coupled amplifier the grid coupling resistors make excellent grid leaks so that the tube functions both as a detector and an amplifier. If a diode detector is used, it should be in an envelope other than that of the first audio stage. A good r.f. choke should be used between the detector and the audio stage and every inch of grid and plate leads in the audio system should be shielded. Then if all the r.f. tubes are removed, the system will be quiet even though a spark coil is operated within a few feet of the amplifier.

Power supply regulation enters into the picture from two angles. First, if loud noise pulses are being received, the plate currents of the r.f. and i.f. tubes are likely to vary over wide limits. If this occurs, the power supply with poor regulation will be modulated in much the same way as a transmitter is modulated. Only in this case the modulation will be noise, not intelligence. The second factor is also important. That is, the adjustment of the silencer with respect to voltage is generally quite critical regardless of the type of silencer employed. As can well be imagined, accurate adjustment of voltage becomes next to impossible if the total voltage available is varying considerably. These difficulties can be overcome easily by using a choke-input filter with a fairly heavy bleeder current drain, or one of the automatically regulated power supplies.

Two more closely related problems remain in the path of a good silencing job. The first of these is that the source of the a.v.c. voltage must be protected against noise impulses. This requirement is fulfilled by the Lamb device as well as by the circuit under discussion. Several systems have been published where this is not the case. With the source of a.v.c. voltage unprotected, a loud and fairly continuous train of noise pulses will develop an increasing amount of negative bias and thus

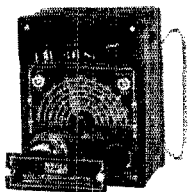

Ranger

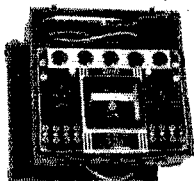

Simpson

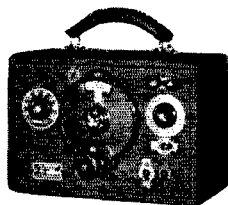

R. C. A.



Clough-Bregle

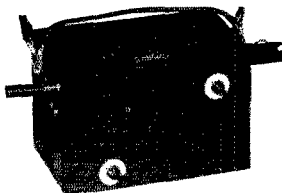

Million

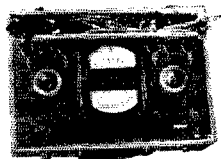

Supreme

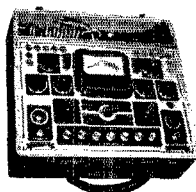

Precision



Triplett

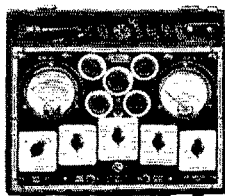

Precision

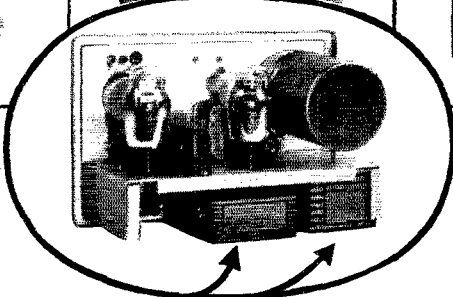

INSIDE

PROOF

of Dependable Test Instruments

Many famous trade-marks identify the leading test instruments used in radio service laboratories. These trade-marks give us confidence in the stamina, precision, and dependability of this equipment. We use them with confidence in the accuracy of the delicate measurements they indicate.

But underneath the trade-mark—inside the box—lies the reason for their satisfactory service—good workmanship—quality materials. It is significant, therefore, that

Burgess Batteries are chosen to power practically all the better known, modern radio test equipment. When you renew cells in your test equipment, buy Burgess for continued accurate performance, just as the manufacturer intended. Use Burgess Batteries in all your experimental work for the same reason. They give the greatest efficiency—lowest cost.

BURGESS BATTERY COMPANY
Freeport Illinois

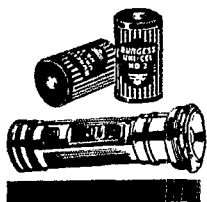

BURGESS



YOU COLUMBUS AMATEURS

make the

HUGHES PETERS ELECTRICAL CORP.

178 N. THIRD STREET

Your Source
for



TRANSFORMERS and ADD-A-UNIT TRANSMITTER KITS

Use a transformer that's really engineered — that does not overheat and that won't feed back. Utah Transformers are electrically and mechanically sound, with uniformly wound coils, ample insulation and careful impregnation. They'll give you better performance and longer life. A complete line is available. Write for Catalog for complete specifications.

UTAH ADD-A-UNIT KIT 80 WATT INPUT

Only \$49-75

Build your own powerful transmitter, simply and easily, with the Utah Add-a-Unit Kit, at a fraction of the cost of a factory assembled job, with Utah built and tested parts. Additional Unit Kits available, that plug in to your first one, so that in time you can have a complete 400 Watt phone transmitter. See your local jobber, or write Dept. Q-6 for complete information.

UTAH RADIO PRODUCTS CO.

CHICAGO, U. S. A.

TORONTO BUENOS AIRES
ONTARIO, CANADA (UCOA RADIO PRODUCTS CO.)

"16 YEARS OF LEADERSHIP"

make the receiver insensitive to anything but very loud signals. In this case, as in the case of the "noise susceptible" audio system, a good silencer will do no good.

The second problem is a bit more difficult of solution. In conventional receiver design fairly large values of resistance and capacity are used in the grid return filters, which are used in all stages to which a.v.c. voltage is supplied. These filters act as grid leaks and condensers with very long time constants when the grids of the amplifier tubes are driven positive by noise pulses. In typical grid-leak detector fashion a negative bias is built up on the grids that effectively reduces the receiver gain for an appreciable length of time. The answer to this problem is the use of a low-impedance source of a.v.c. voltage. That is, instead of securing the a.v.c. voltage from the drop across 100,000 ohms or more, this value should be reduced to something around 15,000 ohms with an appropriate by-pass. The source of common coupling between the various grid circuits is thus made very low. Then much smaller values of decoupling resistors and condensers can be employed without difficulty from interaction or feedback.

In conclusion it would be well to point out that in cases where high selectivity is employed, with a crystal filter for example, protection of the filter is necessary as pointed out by Lamb.² However, there are many cases where this type of selectivity is not used. Then the ease with which the automatic see-saw silencer can be installed is a decided factor in its favor over the i.f. type, as the results obtained in a side-by-side test are comparable.

² Lamb, "More Developments in the Noise-Silencing I.F. Circuit," *QST*, April, 1936.

Omission

The resistor values in the June 3-Stage transmitter, page 23, are as follows: R₁, 100,000 ohms, 1 watt; R₂, 35,000 ohms, 2 watt; R₃, 10,000 ohms, 10 watt; R₄, 10,000 ohms, 10 watt; R₅, 5,000 ohms, 10 watt; R₆, 400 ohms, 10 watt; R₇, 400 ohms, 10 watt.

Midwest Division Convention

FIRST announcement is made of the Midwest Division A.R.R.L. Convention to be held in Kansas City, October 9th and 10th, under the auspices of the Heart of America Radio Club. It is planned to make it the largest ever held in the division, and to provide entertainment, lectures and prizes in keeping. The QRA will be the new \$6,500,000 municipal auditorium. Tickets are now available. For further information write Bob Cooper, W9KNH, Box 7471, Kansas City, Mo.

New! Perfect Portable Power for—

Radio Transmitters

P. A. Systems

Scientific Apparatus

P. R. MALLORY & CO. Inc. MALLORY VIBRAPACK

Dependable, inexpensive,—Mallory Vibrapacks are the ideal sources of plate voltage where commercial electric power is not available. Operating from a 6 volt storage battery, the high voltage models of the Vibrapack will deliver up to 300 volts at 100 m. a. of easily filtered, rectified DC for operating portable radio transmitters, P. A. systems and other equipment. Lower voltage models of Vibrapacks are used where less output is required. Mallory Vibrapacks are ideal for converting 110 volt AC receivers for 6 volt operation.

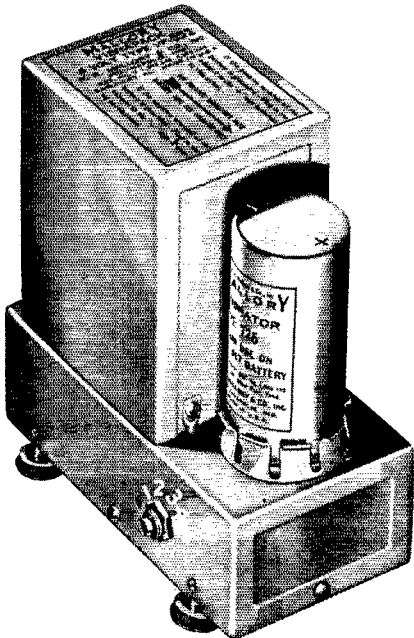

The output of Mallory Vibrapacks is variable in four steps of 25 volts each. The selection of output voltage is obtained through a Yaxley switch connected to various transformer taps. Maximum efficiency is obtained for all load conditions.

Mallory Vibrapacks are made in four models—

Type	Nominal Output Voltage
551—Self-Rectifying	125-150-175-200
552—Self-Rectifying	225-250-275-300
553—Tube Rectifier	125-150-175-200
554—Tube Rectifier	225-250-275-300

Mallory Vibrapacks are supplied complete with special design Mallory Long-Life Vibrator. The rectifier tube is included with Models 553 and 554. Average weight only 5½ lbs.

See the Mallory Vibrapack at your most convenient Mallory-Yaxley distributor. He has your Data Sheet, "Perfect Portable Power"—containing complete specifications and operating instructions. Ask for it!

Use
P. R. MALLORY & CO. Inc.
MALLORY
REPLACEMENT
CONDENSERS... VIBRATORS

P. R. MALLORY & CO., Inc.
INDIANAPOLIS, INDIANA
Cable Address—PELMALLO

Use
YAXLEY
REPLACEMENT
VOLUME CONTROLS

NOW OFF THE PRESS

The new Cardwell Catalog No. 40, with good news for you and handy nomograph charts for choosing the proper variable condenser for any power and band. Ask your dealer or write us.

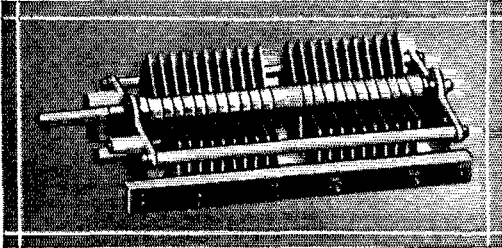

MT-100-GD — Capacity 100-100 mmfd. Most popular condenser for p.p. 50 watt plate modulated amplifiers or for p.p. grids of higher power stages. Airgap — .070". Plates — Buffed and polished. Peak v. — 3500. Insulation — G.E. Mycalex. Net **\$4.80**

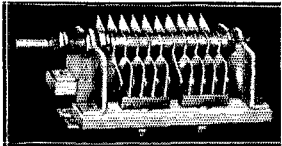

NP-35-ND — Cap. 35-35 m.m.f. The best bet for the 5 meter rig. Push-pull rigs with low power deserve it — higher power requires it. Small enough for portables — big enough for high power fixed 56 M.C. stations. No closed loops — Isolantite insulation — Airgap .084" — Peak flash over — 4200 V., — Buffed and polished plates. Net. **\$3.60**

XE-240-KS

Capacity 240 mmf. max. Correct for antenna networks for 100-200 watt xmtrs. Airgap — .100". Plates — Buffed and polished. Peak v. — 4500. Insulation — G. E. Mycalex. Net **\$6.48**

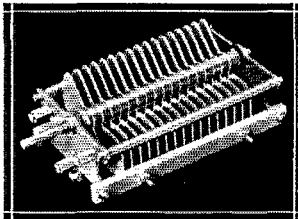

XG-110-KD

Capacity 110-110 mmf. For years the accepted unit for p.p. 200 watt tanks fully modulated. G.E. Mycalex insulation where you need it. Airgap — .171". Plates — Thick, buffed and polished. Peak v. — 6000. Net **\$10.80**

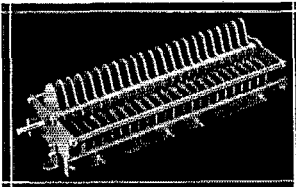

**THE ALLEN D. CARDWELL
MANUFACTURING CORPORATION**
83 PROSPECT STREET, BROOKLYN, NEW YORK

An Effective Linear Filter

(Continued from page 19)

adjustable. The antenna, transmission line and transmitter should be built and adjusted in the normal manner and when operating properly the stub should be connected as shown. Then without retuning or adjusting the transmitter, line or antenna, move the shorting bar up or down on the stub until maximum current flows in the shorting bar. A 0-1 ampere radio-frequency ammeter tapped across part of the shorting bar will allow the point of maximum current in the stub to be determined. On low-power transmitters it may be necessary to use a lower range ammeter or thermogalvanometer to get a good meter indication during adjustment. Incidentally, the current at the shorting bar will be much higher than the line current but it represents circulating current or "wattless power."

When the stub is working properly it will usually be found that the d.c. plate current drawn by the final amplifier has dropped off somewhat, and the amplifier may run noticeably cooler. This is simply an indication that the harmonics are no longer being generated in the final amplifier and will allow the input and output on the fundamental to be increased.

The approximate length of the stub, in feet, can be calculated by dividing 240 by the frequency in megacycles. Also one can divide 240,000 by the frequency in kilocycles, the frequency, of course, being the fundamental frequency of the transmitter.

The following table shows stub lengths for the low-frequency end of each band. Thus if each side of the stub is made the length shown, a small adjustment of the shorting bar will allow resonance to be established for any other frequency in the band. Note that, for obvious reasons, this filter stub is a one-band affair!

Frequency in Megacycles	Stub Length in Feet
1.75 Mc.	136.8
3.5	68.4
7	34.2
14	17.1
28	8.55
56	4.28

This same harmonic filter arrangement is ideal for those using long-line tank circuits on ultra-high-frequency amplifiers. Fig. 2-A shows the conventional plate tank circuit arrangement while that of Fig. 2-B is much more desirable since it prevents the generation of odd harmonics as well as even harmonics in the push-pull amplifier. The plates should be tapped down from the open end of the line one-third of the length of the line, which is approximately a quarter wavelength. Copper or dural tubing is usually used for the line in order to get either high unloaded Q or Z , depending on whether the tubes operate as oscillators or amplifiers.

NOW! Lower Down Payments Than Ever Before! EASY TERMS

These receivers are among the best values money can buy. Our 6% EASY CREDIT PLAN makes it easy to own one. Compare our rates. Send down payment with your order today. Set will be shipped as soon as credit is O.K.'d. Entire transaction 1 week. Order now!

Cash Price Down Payment 6 Months Payments 9 Months Payments 12 Months Payments

NATIONAL NC-100X complete with tubes, crystal and speaker in cabinet.	\$147.60	\$27.60	\$21.10	\$14.21	\$10.80
NATIONAL NC-100 complete with tubes and speaker in cabinet.	\$125.10	\$20.10	\$18.58	\$12.50	\$9.47
NATIONAL NC-101X complete with tubes, crystal and speaker.	\$129.00	\$24.00	\$18.58	\$12.50	\$9.47
NATIONAL HRO with tubes and coils.	\$179.70	\$29.70	\$26.14	\$17.67	\$13.45
NATIONAL HRO with tubes, coils and power supply.	\$195.60	\$35.60	\$27.74	\$18.83	\$14.33
HAMMARLUND SUPER PRO complete with tubes, crystal and 8" speaker.	\$255.70	\$35.70	\$38.08	\$25.78	\$19.64
ACR-155 complete with tubes and built in speaker.	\$74.50	\$14.50	\$11.00	\$7.39	
ACR-175 complete with tubes, crystal and separate speaker.	\$119.50	\$19.50	\$17.74	\$11.93	\$9.02
RME-69 complete with tubes, crystal and speaker in cabinet.	\$151.20	\$26.20	\$21.94	\$14.77	\$11.25
HALLICRAFTER SX-11 complete with tubes and crystal. Speakt	\$12.00 extra.	\$99.50	\$19.50	\$14.36	\$9.66
HALLICRAFTER ULTRA SKYRIDER with tubes and crystal. Speaker \$12.00 extra.	\$114.50	\$19.50	\$16.90	\$11.37	\$8.59

HRO DE LUXE

Only \$29.70 Down
★
1 Year to Pay

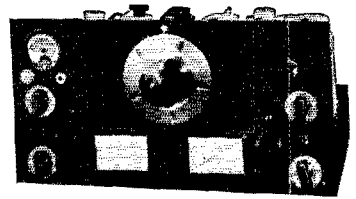

\$179.70 CASH PRICE

Complete Band Spread coverage, 1700 KC to 30,000 KC. Nine Tubes (not including rectifier). Two pre-selector stages. Strictly single-control tuning. Four gang precision condenser with pre-loaded worm drive tuning, 20-1 ratio. Two I. F. stages with Litz-wound coils, air condenser tuned. Beat Frequency Oscillator for "offset" C. W. tuning. Single Signal (Crystal Filter) standard equipment. Direct reading micrometer dial spreads tuning over 500 divisions, numbered every 10 divisions. Buy now on NEWARK'S easy 6% Credit Plan.

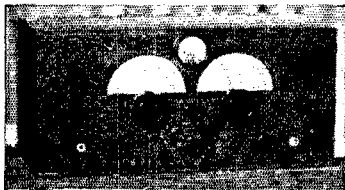

RME 69

Complete with Tubes, Crystal, and Speaker in Cabinet.....

\$151.20 CASH PRICE

This precision built communication type receiver has proven itself to be one of the very best in performance. Features continuous band spread tuning on 6 bands from 9 to 550 meters. The amateur bands are grouped for minimum amount tuning. New large improved dials. Built-in monitor for both phone and C. W. Heavy crackle finish metal cabinet. Uses expensive electrical condenser system of band spreading. Has single crystal filter. (Bliley 456 K.C.) as standard equipment. 9 tubes.

ORDER DIRECT from this ad or write for FREE BULLETIN

Don't wait until you have ready cash. Buy now on NEWARK'S Easy 0% Credit Plan. Send down payment with your order. Sets shipped immediately upon credit approval. No red tape. Entire transaction completed in one week. No matter what set you want, we can furnish it. We stock all new nationally advertised merchandise and sets as released by the better manufacturers from time to time. Easy Terms on Parts and Supplies of \$60 or more. Before You Buy, Write Us!

Added To Our Technical Staff
Harry Harrison W9LLX
Leo B. Wilcox W9BHM
Write to them about your problems

NATIONAL N C 101 X

Buy Now Pay Only \$9.47

per month

ON 12-MONTH PLAN (Small Down Payment)

CASH PRICE

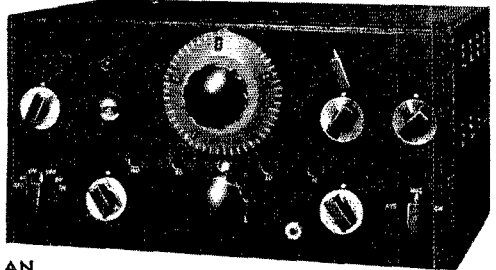

\$129

COMPLETE WITH TUBES, CRYSTAL and SPEAKER

Five band spread ranges, 1.7 to 2.0 megacycles, 3.5 to 4.0 megacycles, 7.0 to 7.3 megacycles, 14.0 to 14.4 megacycles, 28.0 to 30.0 megacycles. Automatic plug in coils. Permanent calibration. Micrometer dial. Amplified, delayed A. V. C. Power output 10 watts. C. W. Oscillator. Crystal Filter. Built-in Power Supply. 12 Tubes — 10" speaker. Our time payment plan makes it easy to own this fine set. See terms listed above.

VERY SPECIAL OIL FILLED AND OIL IMPREGNATED FILTER CONDENSERS

Lucky Purchase of 10,000, all well known makes, enables us to offer astonishing low prices. All Guaranteed at rated voltages. Already sold down to limited supply and going fast. Order now!

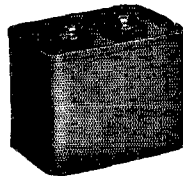

Cap.	Voltage	Size	Weight	Price
1 mfd.	2000 V. DC	5 x 3 1/4 x 1	1 1/4 lbs.	\$1.25
2 mfd.	2000 V. DC	4 3/4 x 3 1/4 x 1 1/2	3 lbs.	1.50
8 mfd.	2000 V. DC	5 x 3 3/4 x 3 1/4	4 lbs.	2.75
9 mfd.	3000 V. DC	5 1/2 x 3 1/2 x 1 1/2	9 lbs.	7.25
(including 2 1/2" Bakelite standoffs)				
4.4 mfd.	1500 V. DC	5 x 3 1/4 x 1 1/4	1 1/2 lbs.	1.75
5 mfd.	1500 V. DC	3 3/4 x 3 3/4 x 1 1/4	1 1/2 lbs.	1.90
5.2 mfd.	1500 V. DC	5 x 3 1/4 x 2 1/4	2 1/2 lbs.	2.00

NEWARK ELECTRIC COMPANY

226 W. MADISON ST. Dept. Q CHICAGO, ILL.

LEEDS with thousands of different items usually has what you need. *Write us about it.*

RACK PANELS

by **LEEDS**

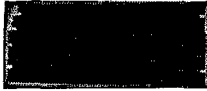

are furnished with black shrivel finish in the standard 19" length, 3/4" thick. Western Electric mounting slots of Amateur slotting. Masonite Panels, crystalline black and silver gray in W. E. slotting, 3/4" thick.

Steel	Price	Width	Aluminum	Price	Masonite
PS-1.....	\$.52	1 3/4"	PA-1.....	\$.74	\$.36
PS-2.....	.57	3 1/4"	PA-2.....	1.03	.48
PS-3.....	.68	5 1/4"	PA-3.....	1.30	.54
PS-4.....	.71	7 1/4"	PA-4.....	1.55	.69
PS-5.....	.95	8 1/4"	PA-5.....	1.90	.87
PS-6.....	1.15	10 1/4"	PA-6.....	2.45	1.05
PS-7.....	1.30	12 1/4"	PA-7.....	2.90	1.23
PS-8.....	1.50	14"	PA-8.....	3.35	
PS-9.....	1.70	15 1/2"	PA-9.....	3.70	
PS-10.....	1.90	17 1/2"	PA-10.....	3.95	
PS-11.....	2.05	19 1/2"	PA-11.....	4.45	
PS-12.....	2.30	21"	PA-12.....	5.20	

Other sizes —
Price on request.
State slotting desired in order.

VICTRON "G" — The Magic Insulator of Radio

You've heard enough about it, so no need to describe it.

Thick.	6 x 12	6 x 6	1 x 12	Cond. Strips	
3/16"	\$3.60	\$2.00	\$.75	3/4 x 3/16 x 12"	\$.35
1/4"	2.50	1.35	.45	3/8 x 1/4 x 12"	.60
1/16"	1.40	.75	.25		

Q-Max No. 3 R.F. Lacquer 1/4 pint \$.25 1 pint \$1.75
Q-Max Crystallite Black 1/4 pint \$.25 1 pint \$1.75

PAWOOD metal punch for drilling holes; we have the following sizes:

3/4" — 3/8" — 1/2" — 1 1/4" — 1 3/16" — 1 1/2" each	\$1.67
No. 5 heavy duty circle cutter, 1 to 5 1/2" dia.	1.85
No. 4 heavy duty circle cutter, 1 to 4 1/2" dia.	1.29
Extra blades24c

LEEDS Copper Wire Specials

Enameled

No. 14...40c. No. 12...60c. No. 10...90c.
Copperweld, steel core enameled. No. 14...65c. No. 12...95c. Phosphor Bronze — harddrawn — stretchless and kinkless; high tensile strength, No. 12...\$1.25. Seven strands No. 20 phosphor bronze...\$1.50. Prices quoted above are in 100-foot lengths. Larger quantities in one piece are available.

HEINEMANN Circuit Breaker

In attractive bakelite case, easily mounted on panel. Size 4 1/4 x 2 1/4 x 3 1/4; single pole, connected in series with primary. 7 models 5 to 35 amp, 115 volt. Special.....\$3.90

LEEDS

Completely shielded High Voltage

Transformers

Made for us by one of the most reputable manufacturers in this field.

300 MA

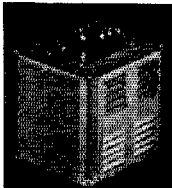

750-1000 v. each side.....	\$5.20
1000-1250-1500 v. each side.....	6.75
1500-2000-2500 v. each side.....	10.95
Type P — 1200 v. C.T. at 200 ma; 5 v. at 3 amp; 2 1/2 v. at 10 amp; 7 1/2 v. tapped at 6.3 at 2 1/4 v. Special.....	\$2.95

LEEDS CHOKES IN METAL CASE SIMILAR TO ABOVE ILLUSTRATION

20 Henry Smoothing — 5-25 H. Swinging
62-F 200 MA...\$1.45...62-FS...200 MA
62-G 300 MA...2.85...62-GS...300 MA
62-H 400 MA...3.45...62-HS...400 MA
62-I 550 MA...4.95...62-IS...550 MA



LEADS THE FIELD

World Wide Service to Amateurs

45 Vesey Street
New York City

Tel. COrtland 7-2612

Cable Address: "RADLEEDS"



Crystals LD-5. Mounted crystals. Unconditionally guaranteed; cut to your specified frequency in the 40-90 and 160 meter bands at no extra cost. Only.....\$3.50

Money back guarantee if you are not completely satisfied. LEEDS type A.L. metal crystal holder, as illustrated above, fits standard 5-prong socket.....89c

Pyrex strain insulators 3 1/2" dia.....17c

Pyrex strain insulators 2" dia.....69c

Lead in bushings and 15" brass rod...\$1.47

Complete line of Johnson & Birnbach products in stock

General Radio

Variacs and parts in stock

677-U coil forms, 21 turns, 2 1/2" dia. resonant on 3.5 mc. 100 mfd. cap.....50c
677-V — 30 turns 4" dia. resonant 1.7 mc. 100 mfd. cap.....75c

A Four-Band Portable

(Continued from page 24)

plugging L_2 into the plate circuit and L_1 into the grid-cathode circuit. The tuning capacity C_1 is turned to near maximum capacity, where the plate circuit is resonant at the crystal frequency. To tune to 20 meters the same coils are left in their sockets and the condenser simply moved to near minimum capacity. The tube now acts as a doubler and the output is on 20 meters. Resonance dips are well defined on the plate current meter.

To tune to 10 meters, the coils are reversed and the condenser will hit resonance with the fourth harmonic of the 40-meter crystal at about one-third capacity. The resonance dip of plate current is more pronounced than on 40 and 20 meters, dropping from 70 ma. out of resonance to 60 ma. in resonance, depending upon the activity of the 40-meter crystal employed. Some crystals vary slightly from the above values, but all good crystals will give high 10-meter output. The output will light a 6.3-volt test lamp to full brilliancy when coupled loosely to the plate tank with two turns one inch in diameter.

In order fully to excite the push-push doubler-amplifier the grid circuit is tuned to resonance by C_2 . An untuned, or aperiodic, circuit may be inserted here if desired, with some loss in final output. The importance of C_4 previously has been stressed. Neutralization is not necessary as the output tube is always a frequency doubler as well as an amplifier of input power from the crystal oscillator.

The plate current of the tubes is indicated simultaneously on the same milliammeter. The crystal tube current has been mentioned as 60 ma. in resonance, but with the amplifier grid and plate coils removed. Introduction of the amplifier grid circuit plug-in coil and tuning C_3 to resonance loads the crystal oscillator plate current to 70 ma. When the plate tank coil is also plugged in the total meter reading will be around 110 ma. or an amplifier current of 40 ma. out of resonance.

When the amplifier plate tank is swung to resonance the total current drops to about 90 ma. or approximately 6.5 watts input to the amplifier, antenna not connected. The tube runs cool with this treatment and when the antenna is introduced the total current loads up to about 120 ma., which corresponds to an amplifier input of 16.25 watts (50 ma. x 325 volts).

The transmitter is built into an 8 1/4 by 12 by 6 1/2-inch chassis with large ventilating louvers at each side, and several half-inch holes are punched at the rear and in the cover for air circulation. A protective metal cover is placed over the crystal for mobile or portable use.

Talking about brass, read this one from VE3BE: "A guy bootlegged my call and then sent me an anonymous letter saying he had at last clicked with his first contact and would I be so kind as to QSL as he didn't have one and did not wish to go back on his promise to QSL." Nice feller!

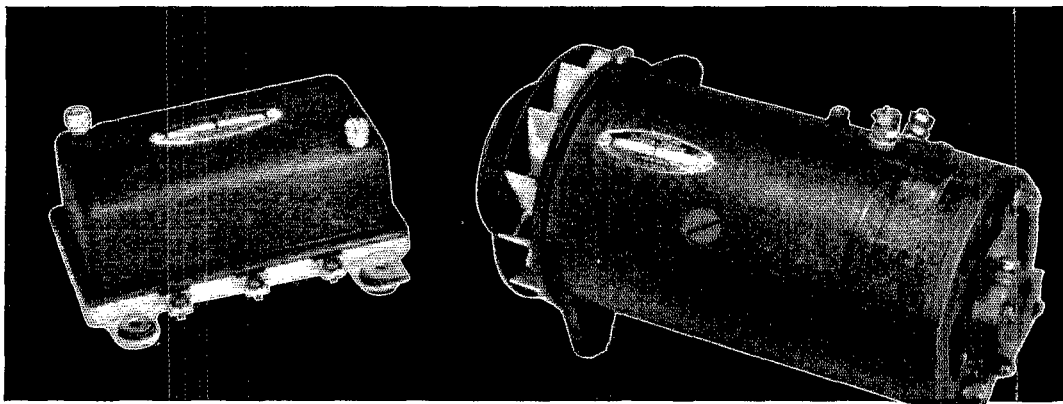

Announcing THE NEW DELCO-REMY MODEL 961-N GENERATOR FOR RADIO- EQUIPPED PASSENGER CARS

Amateur radio operators and car owners with auto radio installations—here is the answer to those additional current requirements for your radio and extra equipment. The new Delco-Remy Model 961-N Generator is a low-cost unit that makes available a 26-28 ampere output, when needed.

This new Special Service Generator is complete with Current and Voltage Regulator, wiring and all necessary attaching parts. The Delco-Remy regulator controls the voltage *at the battery*, preventing battery overcharging and excessive voltage within the electrical system—and *it does not cause radio interference*.

Delco-Remy Model 961-N Generators may be installed on most cars. Any Branch or Electrical Service Station of United Motors can supply them.

FOR POLICE CAR SERVICE: *Delco-Remy heavy-duty generators of the 934 type are available for installation on most cars, in either City Police or State Police Service.*

Delco-Remy



Delco-Remy products are sold and serviced by United Motors Service everywhere... wherever you see this sign.

World's Largest Manufacturer of Automotive Electrical Equipment

Say You Saw It in QST — It Identifies You and Helps QST

THE *Grass* STOCK

of Transmitting and Receiving Radio Equipment is one of the Largest in the World

Test Equipment Carried in Stock

Oscillographs—Oscillators—Tube Testers—Volt Ohm Milliammeters—Modulation Monitors

RCA ★ SUPREME ★ TRIPLETT ★ DUMONT
WEBBER ★ PRECISION ★ CLOUGH-BREngle
SIMPSON ★ RANGER ★ READRITE ★ BURTON

Brush Crystal Phones	\$5.25
Trimm Featherweight Phones	5.88
Shure 701A Crystal Mike	14.70
Tri-Tan Crystal Pickup	6.80
Astatic D-104 Crystal Mike	13.23
Shure Zephyr Crystal Pickup	7.05
Single Button Mikes	2.25

PREMIER MOUNTED CRYSTALS

40-80 Meter Bands	\$4.35
UNMOUNTED CRYSTALS	2.25

KEYING RELAY

will operate on one dry cell. Can be used as Single Pole Single Throw or Single Pole Double Throw. Sturdy construction, has 1/2" diameter Solid Silver Contacts. Compares favorably with expensive types. Special

59c



Gross Value on U.T.C. Transformers

Cased, Stand Off Bushings, Universal Mounting	
Type A — Delivers 750/1000 volts A.C. at 300 M.A.	\$5.20
Type B — Delivers 1000/1250/1500 volts A.C. at 300 M.A.	6.75
Type C — Delivers 1500/2000/2500 volts A.C. at 300 M.A.	10.95
Type D — Delivers 1000/1250/1500 volts A.C. at 500 M.A.	10.95

THORDARSON CASED TRANSFORMER

600 volts each side of C.T. 200 MA 2 1/2 V. 10 amps. C.T., 5 V. 3 amps. 7 1/2 V. 3 amps. C.T.	\$2.45
THORD. CHOKE 12 H 250 MA.	\$1.95
THORD. 15 H 250 MA CHOKES	2.95

MAC-KEY Semi-Automatic and Straight OSCILLATOR \$7.95

HEAVY DUTY ANTENNA KNIFE SWITCH

Single Pole, Double Throw 100 Amperes, 5" Break \$1.45

NEW !! STATION CHIMES

4-Plate Type with Mallet
SPECIAL \$4.50

PORCELAIN BASE 50-WATT SOCKETS

(Side wiping contacts) \$5.88

NEW !! HOYT BAKELITE CASE HOT WIRE ANTENNA METER

3 1/2" Across Flange, Mounts through 2 1/2" hole. Scale Length 1 1/2". Ranges: 0/1.5 Amps. \$3.20

GROSS RADIO, INC.

51 VESEY STREET NEW YORK

Cable Address: GROSSINC

W3FAR Wins 28-Mc. Contest

(Continued from page 29)

conditions were poorest, a half-wave vertical radiator exactly a half wave above ground proved itself capable of working short-skip stations (within 1000 miles) when they could never be raised with the horizontal flat top. Experimentation at W3FAR is being continued and records kept during 1937 to compare with the complete '36 data.

We regret that space is inadequate to permit us to detail the experimentation at the other leading stations, but each participant built considerable new equipment. W8JFC used several arrays successfully. W3BRZ found a 133-foot flat-top, one of the most practical of many antenna combinations for 28 Mc. W9HUV did 80 per cent of his work with a similar antenna. A half-wave vertical, with matching stub and 500-ohm line was nearly as consistent, but gave lower S-reports. Two half-wave antennas with reversing stub between, stacked vertically, and a half-wave vertical doublet were also tried. To all entrants our congratulations on the very successful work performed and the outstanding entries submitted.

—F. E. II.

Oklahoma State Convention

Tulsa, Okla., July 17th-18th

THE director and executive committee of A.R.R.L. have formally approved the Oklahoma State Convention to be held at the Hotel Alvin, Tulsa, Okla., July 17th and 18th.

The Tulsa Amateur Radio Club sponsoring the affair cordially extends to all amateurs a cordial invitation to be present at this convention. Plenty of entertainment, prizes, stag party and all for the low registration fee of \$1.98. All registrations received prior to July 1st will be eligible for special pre-registration prize.

Send registrations to Ronnie Durham, c/o Radio, Inc., Tulsa, Okla.

Silent Keys

IT IS with deep regret that we record the passing of these amateurs:

Fred E. Bayer, VE1AG, Musquodoboit Harbor, N. S.

William Gibbons, W9TAK, Hazle Crest, Ill.

Leroy K. Gilbert, W9GHH, Maplewood, Mo.

Raymond M. Rebbe, W9EGD, Bartonville, Ill.

T. V. E. Seeley, VE2IQ, Shawinigan Falls, Que.

J. J. Ryan, VE2AI, Hampstead, Que.

VACUUM **EIMAC** TUBES

LOGICAL CHOICE FOR YOUR CLASS "B" MODULATORS

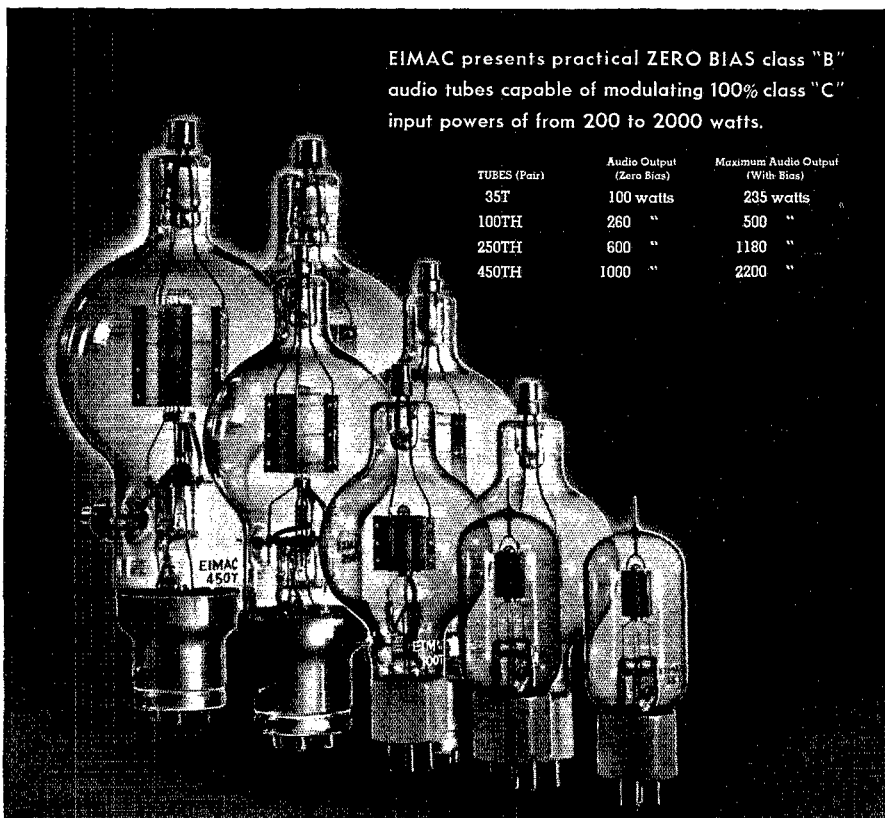

EIMAC presents practical ZERO BIAS class "B" audio tubes capable of modulating 100% class "C" input powers of from 200 to 2000 watts.

TUBES (Pair)	Audio Output (Zero Bias)	Maximum Audio Output (With Bias)
35T	100 watts	235 watts
100TH	260 "	500 "
250TH	600 "	1180 "
450TH	1000 "	2200 "

ADVANTAGES OF EIMAC TUBES AS MODULATORS

- (1) Practical zero bias operation with audio outputs up to 1 KW.
- (2) Extended power capabilities with higher plate voltages and a minimum of bias.
- (3) Tubes are designed to operate with maximum possible "static" input. Such practice tends to approximate push-pull class "A" operation.
 - (a) High static plate currents minimize power supply regulation requirements.
- (4) Low interelectrode capacities prevent loss of the higher audio frequencies.
- (5) Uniform characteristics make unnecessary "special matching" of tubes.
- (6) Grid characteristics free from "kinks" caused by secondary emission and gas currents which minimize possibilities of "self-oscillation" and "fuzz."
- (7) "Cheapest" possible audio watts. Tube cost vs. power capabilities is probably the lowest in the industry today.

See these tubes at your dealer's today.

EITEL-McCULLOUGH, INC.

San Bruno, California, U. S. A.

Say You Saw It in QST — It Identifies You and Helps QST

Station Activities

(Continued from page 48)

a score exceeding 20,000 in the VE/W contest. UD has been testing a 'phone rig on 56 Mc. with good success. RJ is moving his well-known 3.9-Mc. 'phone to 14 Mc. for the summer. XB can be heard in the late evenings pestering the DX. PQ is back on lining up traffic schedules, rag-chewing and taking pot-shots at DX. XM moved back to the old QTH. UK and BD have nice success on 14-Mc. 'phone. KJ and QM are heard consistently on 3.9-Mc. 'phone. CM gets abnormal antenna current (1.5 amps) with 48 watts input. UQ still keeps his Sunday Vancouver QSO. LJ is at the San. for a few months.

Traffic: VE4PQ 10 QZ 3 EL 7 BF 2.

MARITIME DIVISION

MARITIME—SCM, A. M. Crowell, VE1DQ—Nova Scotia: HJ has new gas generator. JK is battling away on 3690 kc. KJ handled his first bunch of traffic and got a real kick out of it. EA is piling up the QSL's from VK and ZL on the DX tests. It is our sad duty to record this month the passing of one of the old-timers and best known amateurs of this Section. Fred E. Bayer, VE1AG of Musquodoboit Harbor, has joined the ranks of "Silent Keys." AG, though operating under many handicaps, without power mains, and maintaining a gas engine to keep batteries charged, became one of the most popular 3.9-Mc. 'phones. His cheery voice will indeed be missed by all of us, and the writer has lost a personal friend of many years. Our sincere condolences to family and relatives. St. John—CE was heard testing on 3.5-Mc. 'phone. EI is talking about 14-Mc. 'phone. EJ is getting 56-Mc. rig ready for car. EL is experimenting on a 56-Mc. mobile transceiver. GP has a new 60-ft. mast. GQ is chairman of Technical Committee of L.C.A.R.C. IF has new license endorsed for 14 and 3.9 Mc. IZ has a new suppressor-modulated rig—RK-23. JN has new 56-Mc. rig. BM is experimenting on 1.75-Mc. 'phone. KZ is owned and operated by EE and JN at their place of business. LC is the call of the Loyalist City Amateur Club station. IE worked London and followed the coronation program within a week after his license was endorsed. Moncton: CX is doing some 56-Mc. experimenting. JU is going FB with 6L6 c.c. oscillator. EL is putting a self-excited rig on 14 Mc. using a pair of 211's. IJ has new rig perking on 7 Mc. DC and GI moved to new QTH's. EV had the filter on his final supply go west. IL has his rig perking on 14 Mc. IR is a new member of the Moncton Club. KS is on 1772-ke. 'phone from Sackville. **WARNING! KEEP THESE DATES OPEN—SEPT. 4TH, 5TH and 6TH—FOR THE H.A.R.C. HAMFEST AT HALIFAX.** Newfoundland News (via VO1W): VO4Y went over to England with his daughter for the Coronation. VO4A came to St. Johns for the Coronation; he arrived about 2:30 A.M. Tuesday 11th and was met by 1I, 1P, 1M, 1W and two S.W.L.'s. VO2N is quite active on 14-Mc. 'phone. May 12th was our biggest day for Portables so far this year. VO1J/P with the Collins and HRO operated at Ouidi Vidi Lake, just outside of St. Johns, where the fireworks display was held. He was key station. On Signal Hill VO1H/P with VO1H and VO1O ops were stationed at bonfire site using portable receiver and transmitter. VO1W/P was on the South Side hills with 1W as chief op and 1M, 1Y, 1C and two S.W.L.'s; 3.5-Mc. c.w. was used by 1H/P and 1W/P and 1J/P was on 3.9-Mc. 'phone. 1Y and S.W.L. and 1C and S.W.L. were used for runners to the sites of the other two bonfires about 300 yards away. Contact was held from 7:30 to 10:30 and everything went thru without a hitch. Stations were used to see that everything (bonfires and fireworks) went off per schedule. VO1P built a signal squitter for 14 Mc. VO1Y has new Sky Challenger. VO1S is active over VO1I and schedules VO4C daily. VO1M is working DX on 7 Mc. VO1X is active on 14-Mc. 'phone. VO1W is active on 3.5 and 7 Mc. VO4C is trying to get on 14-Mc. 'phone. VO2Z got new bottle for final.

Traffic: VE1JK 11 HJ 9 KJ-EV 7.

ONTARIO DIVISION

ONTARIO—SCM, Fred H. B. Saxon, VE3SG—R.M.'s: 3DU, 3GT, 3MB, 3ABW, 3QK, 3TM, 3WK, 3WX. P.A.M.: 3NX. The Toronto clubs are holding a picnic and hamfest at Hanlan's point, Toronto Island, Saturday after-

noon and evening, July 24th. Tickets are 15 cents each or two for a quarter. CA and ACL are looking forward to O.P.S. PE, QB and VC are qualifying for O.R.S. At a dinner held in one of the local hotels, Mr. Ernie Swan told the Queen City Club all about CKCL. VN changed QTH to Leech Gold Mines. AGM is using driver stage, P.P. 801's, until new 100TH arrives. AFR has copper tube vertical antenna for 14 Mc. VC (Brantford) had dinner with the S.C.M. and YF. LU decorated the shack using an Asian motif. ABF has new car. ZG is still looking for the elusive W7 card. YQ is unscrambling his speech amplifier. Lakehead Wireless Club's new executive is: Pres., GS; Vice-Pres., Dr. Quackenbush; Secy.-Treas., AGA. They are going to install VE3UE at Canadian Lakehead Exposition in August. Watch for them and take their traffic. HU is on 7 Mc. after an absence of three years. FW is trying 28 Mc. AML is on 7 Mc. GS has FB 14-Mc. 'phone. BV wants to put his 'phone on 3.9 Mc. New calls in Fort William: ANG and AOD, in Port Arthur: ANP, UA threw out '42's for 6L6's. FY is transferred from Ignace to Fort William; during day he is Canadian Pacific op. ZU is rebuilding for 14 Mc. AND is newcomer in Smithville. ANY is new in Toronto. PH is back home in Ottawa from McGill University; he is rebuilding to a pair of 35T's. AGO (ex-2ER) is now in Ottawa. AEW is new in Lynedoch and is on 7 Mc. AMA, Simcoe, is on 1.75 MC. AMP is on 3.5 Mc. AOU is newcomer in Toronto on 1.75-Mc. 'phone. The Toronto Short-Wave Club executive for the '37/'38 season is: Pres., R. B. Law; Secy., H. Robertson; Treas., L. Kerswell; Activities Mgr. E. Bain. PL is going to Alberta again this summer after "Dinny" bones, and while there will use VE4TA; on his return east his QTH will be Toronto, as he is joining the staff of U. of T. AHO is at Jach Fish Island operating C74I for the Ontario Forestry Branch. ABY builds boats by day to be able to "ham" at night. ABM burned up his rig. UF reports for the Timmins gang—he's it; he placed third VE in the D.J.D.C. contest. EN looks for DX with a T55. ADJ is trying to clear the bugs out of his 802 juv. BB is using a 6L6. DU works plenty of Aussies on 14 Mc. GT is QRL with Kiwanis Boys K Club and is bringing on a fine bunch of new ops. ABW, ADU and YE, all motorcycle riders, started from Toronto, picked up VZ and DO in Hamilton, went on to visit SS in Welland and while there contacted XX near Port Colborne, so the whole gang went there for a hamfest. The S.C.M. visited the North Toronto Club, when Mr. Lawson and ABW described and demonstrated a new 15-tube superhet. The crystal filter in this receiver has a 172.5-ke. bar mounted in a vacuum tube, which was especially imported from England for this receiver. The set has an undistorted output of 10 watts.

Traffic: VE3SG 109 WK 47 SS 40 QZ-DU 23 MB 12 CP 10 ABW-GT 6 YQ 5 KM 4 DB-ALR-AGM-VC 2 AKA 1.

QUEBEC DIVISION

QUEBEC—SCM, Stan Comach, VE2EE—We regret to learn that BE is moving out of the Province to Ontario. Good DX and Happy Landings, Daddy. BE is using a T55 final. GA has worked nine U9 stations. BC has a nice 14-Mc. 'phone. EX is using a vertical radiator, a 10-foot mast on the roof. BT was chief erection engineer while BG strained his neck looking up from the ground. HT has purchased an oscilloscope. BW was visitor at Quebec and stayed with HT while in Montreal. GQ is new station in Snowdon. KM has a new rig. After twenty years the Army has got BU again; he has joined the Signal Corps. KS has completed part of his new rig. HI has new transmitter with band-switching and pre-tuning. KK built himself a new receiver. DQ blew a 6L6 in the doubler. CX is active with AX, FO and some others on 56 Mc. GN will soon be marching down the aisle. Congrats, Ben. LQ was a visitor in Montreal for ten days. BO is recovering from an accident that nearly cost him his left arm. IR has gone to New York for special treatment on his leg. DV, JN and CU are still operating in the mining district. Silent Keys lists two of our number: IQ and AL . . . RIP. AY has joined the R.C.N.V.R. DD is still working in Montreal. IO is using Class A modulation. IC was in Montreal for a few days. D4UAO has gone North on missionary work. IJ is contemplating moving to Montreal. The date for the M.A.R. Club Annual Picnic has been set for July 1st. The place, Pine Grove Park, Chambly Canton, 15 miles from Montreal. Call LV, KS, CO or EE for information.

Traffic: VE2 HT 34 LU-KF 6 JK 5 EC 7 DR 23 KM 12 BU 19 HH 15.

NEW ENGLAND DIVISION

CONNECTICUT—SCM, Frederick Ellis, Jr., WICTI—The Nutmeggers put this Section on top of the heap in traffic handling during the '36-'37 season and your S.C.M. wishes to thank all those who took part for their efforts. HSX moved to 14 Mc. Hal, at AW, had a chance to get in some rag chewing. JTD will have a new sky-wire for 14 Mc. JXP will operate in a 56-Mc. net. UE made a field trip. IMV handles A.A.R.S. work on 1.75 Mc. GKM's schedule with VE2BU is still perking three mornings a week. BDI is busy studying possible locations for WIAW memorial station. ITI says KGX moved in three doors away. JFN made trip to Hudson and Atlantic Divisions; he has proposed to JXP that they start a Conn. shore-line 56-Mc. net to be known as the "Crab Net." KJP is rebuilding and working in a radio store. BHM worked 50 foreigners in a week on 14 Mc. EFW says Unit 2 U.S.N.R. is going full blast at GYT, Meriden Airport. Visitors are welcome at the airport, especially N.C.R. members. JUD is working 14 Mc. TD turned in a good score in O.R.S. party. BQS reports that EWD put on a kw. rig. JHK was the only station to report by radio this month. DWP enjoyed O.P.S. party. HTS moved. KMM came on the air with a 6L6 crystal osc. pushing a '10. CUH is on 7062 kc. The Nutmeg Net gang held a get-together May 2nd at Trinity College. BDI had a sweet little portable transmitter along with him and showed it to the gang. A fine buffet supper was served by the college dining room with entertainment furnished by BFS and his sax. Many thanks to GKM for taking care of the details of this meeting. It was a fitting climax to a season of real traffic activity.

Traffic: WHSX 574 AW 340 JXP 312 UE 103 JYE 85 IMV 61 GKM 54 KFN 47 BDI 44 JQD 40 CTI 38 ITI-GMB 20 JFN 17 KJP 16 BHM 9 HYP-EFW 6 JUD-TD 4 BNB-BQS 3 JHK 2 DWP 1 ES 7 DMP 138 KV 73 (WLGJ 44) FAJ 15 JMY 83 AJB 172 (WLG 66).

MAINE—SCM, John W. Singleton, WICDX—Well, gang, this is my last report as your S.C.M. I want to take this opportunity to thank all of you who have stood by and helped to put Maine on the map. I hearby offer the new S.C.M. my whole-hearted support. Let's get behind the new S.C.M. and put Maine over this season.

Traffic: W1ST 438 IVV 225 INW 247 GOJ 187 HSD 76 IBR 65 CDX 6.

EASTERN MASSACHUSETTS—SCM, Albert N. Giddis, WIABG—IHI shows the boys how! AKS is busy on 7-Mc. net. JCK inquires about O.R.S. ABG had fun in W/VE Contest. AGX is moving to 14 Mc. for the summer. HWE is on 7 Mc. with 25 watts. DMF is getting ready to put up a couple of masts. JNU is thinking of link-coupling the r.f. current in his power supply to the antenna! KH chalked up two more hamfests! IUQ has a new "bug." BEF is publishing M.V.A.R.C. paper, "The Hamspeaker," and is it "hot"! IIN has new Vibroplex key. JTM visited Geneva, N. Y., calling on hams en route. IIC keeps Fall River on the map. JSK is knocking 'em dead with a cool (?) kilowatt on all bands. JZN is new O.B.S. HIL is interested in O.P.S. FZH reports BBM logged couple of W9 stations on 56 Mc. WV has now contacted 665 "G's" . . . a regular "G" man! FKV is working down on the Cape. SW is still perking as evidenced by a letter from EFM.

Traffic: WIHI 642 AKS 375 (WLGQ 167) JCK 367 ABG 288 AGX 226 HWE 208 IWC 188 INA 162 FRO 158 EMG 125 DMF 143 JNU 125 FAR 123 BMW 108 JFS 96 KH 92 EPE-IUQ 81 BEF 73 JNF 56 HFJ 88 JMS 87 IIN 40 JTM 29 GLE 26 IIC 25 FCR 22 HKY 19 HKK 21 QW 17 (CCIC 40) RE 17 JSK 11 IVX 8 HCH 6 JID 4 JYJ 3 JZN 2 HIL-IFR 1 (Mar.-Apr.: W1JNF 89 FCR 30).

WESTERN MASSACHUSETTS—SCM, William J. Barrett, W1JAH—IOR made the B.P.L. for last time before taking it easy for the summer. IOT is new S.N.C.S. for West. Mass. Congrats, Heck, ZB is still clicking daily on his WCFT schedule, putting his total countries into three figures. BVR attended first Board Meeting as our Director. EOB handled Mother's Day traffic from K5AY. BKG is getting 56-Mc. rig in shape for summer. JAH attended Providence Convention. DUZ is installing a battery-a.c. receiver for emergency work. IZW is taking a shot at 56 Mc. HJR is building t.r.f. receiver into his suitcase transmitter. BNL is building two exciters and two finals into same cabinet. KOA reports himself and KNF new hams in Ludlow—Welcome, fellows—hope to hear from you and all the new men often. ISN reports West. Mass. Radio Club very active. COI has e.c. perking on 3.9-Mc. 'phone. AJ visited W2 and

W8 territory. KJK is working on antenna with cable cutters and soldering torch—that's the spirit, George, a DB in the skywire is worth two in the final. IPK sticks to 56 Mc. KJV sold e.w. rig in favor of 56 Mc. We need a reliable station in every community for possible emergencies, which are nothing new for West. Mass. If you fellows will help out, we should be able to line up the best Section in the League, but a few of us can't swing it alone. Let's go.

Traffic: W1IOR 271 IOT 135 (WLGJ 127) ZB 108 BVR 43 (WLG 148) EOB 31 BKG 21 AJD 16 JAH 12 DUZ 11 BKQ 7 IZW 2.

NEW HAMPSHIRE—SCM, Carl E. Evans, W1BFT—The M.V.A.R.A. made plans to operate portable in the Field Day from EAW's summer camp on the side of Mt. Kearsarge. BJF is now a proud father. Congrats, OM. IP is active on 56 Mc. until next fall. IDY has his new outfit working. DKJ is working on a flood-control project at Allenstown and operating on 3.5-Mc. portable in Pembroke. HJI is busy DXing on 14 Mc. and has worked a lot of new countries. HJM graduated from radio school and is now working for WHEB. CEA reports the Farmers' Net still going strong. IDQ returned from Florida and may be heard on 3.5 Mc. ITF is now a Class A Emergency Corps station. N.H.E.N. drills are expected to be resumed again on the third Sunday in September. GKE has a new V-8 convertible coupé. JDP is increasing power on 56 Mc. TA is thinking of installing a 56-Mc. transceiver in his club's new airplane. KIN and HGV have applied for O.R.S. APK has completed a new emergency transmitter. JJD is building a power supply for an RK-20 amplifier. BHJ is rebuilding his 56-Mc. beam so that he can control it from the operating table. BII is back on 56 Mc. BFT has a new transmitter under construction using an RK-25 and an RK-28 for use on 1.7 to 4 Mc. KKQ is a new YL operator in Nashua.

Traffic: W1IP 280 FFL 188 (WLG 79) BFT 131 GMM 99 CEA 56 IDY 47 JDP 14 ITF-HJI 4.

RHODE ISLAND—SCM, Clayton C. Gordon, W1HRC—JYT has 2nd class Teleg. Commercial ticket. JFK had to take rig apart to get it out the door to move to new location. JFG has new 60-foot mast. IHW on 56-Mc. portable. HJ got married and moved to new QTH. JNO has 56-Mc. rig, which was inspired by JFF going mobile 56 Mc. BVI has rebuilt rig for 14-Mc. 'phone. JAH paid HRC another visit just prior to the Convention. JXA built an experimental electric organ to demonstrate at the Convention. IQF has moved to Wickford. DAH and FAH joined the landed gentry—having acquired the use of a large tract out in Scituate somewhere to experiment with directional array and stuff. GTN has new gas-buggy. INU now holds WLGW call, and when tried to use new tube won in A.A.R.S. contest rig went all to heck. BVR seems to have made a hit with the Rhode Island gang by the way he conducted himself at the Board Meeting. HEE built a c/r "silyscope" with all the fixins. IZO is new O.R.S.

Traffic: W1INU 643 IEG 85 (WLGK 154) GTN 83 HRC 7.

VERMONT—SCM, Alvin H. Battison, W1GNF—C.R.M.: IFSV, R.M.: 1EZ, P.A.M.: 1A VP, KJG and UC visited AHN. GAE is gathering parts for his new transmitter. ATF is marking time until "Rural Electrification" reaches his home. KJG and IQG visited at GNF. BJP is burning the ether with a pair of T55's. BZ prepared for the Field Day trials. JKE moved back to Pittsford. IRO is incorporating some new ideas in a 1-kw. instant QSY transmitter. DEZ is hitting the bright spots. AHN served on the Grand Jury. HEV moved to new QTH. HD is employed at WNBX. IQG has a new truck. JHK visited GNF by land wire. FSW and GAZ visited GAE.

Traffic: W1FSV 126 GAE 14 GNF 3 KJG 2 AHN 1.

ATLANTIC DIVISION

EASTERN PENNSYLVANIA—SCM, James M. Bruning, W3EZ, R.M.'s: 3AKB, 3AQN, 3EOP, 3ASW, P.A.M.: 3EOZ, 8BQ is a former S.C.M. returning to Section activities as an Official Observer. 3FRY made W.A.C. in 24 hours last month, and this month reports a new W.A.C. of 6 hours. 3GMK is now using full break-in with crystal keying. 3GLQ wants to buy a bug. 3AQN continues to give good service on what traffic comes his way. 3EML has returned to the air. (Some of you may remember him as old 3CHK back in 1926.) 3GJY has been doing some fine 'phone work with 15 watts input to a 28-Mc. Johnson Q nobly as-

(Continued on page 78)

It's Not All Pink Slips in Washington . . .

If you're getting the equivalent of pink slips in your present position, why not train yourself, as so many other amateurs have done, for responsible jobs in the Radio Engineering field? New advancements in broadcast and aviation radio offer new opportunities for men with technical training.

Investigate Our 1-Year Residence Course in PRACTICAL RADIO ENGINEERING

In less than one year of training in our Washington School, we can qualify you to enter the Radio Engineering field. Completely equipped laboratories, shops, modern working equipment. Class begins in September. Make plans now. Write for our "Tested Plan" that fully explains our course and methods of payment.



Write for Free 48-Page Booklet "A Tested Plan for a Future in Practical Radio Engineering."

CAPITOL RADIO ENGINEERING INSTITUTE

WASHINGTON, D. C.
14th and Park Road

Dept.
Q-7

NEW YORK CITY
29 Broadway



Standard Frequency Transmissions

Date	Schedule	Station	Date	Schedule	Station
July 2	B	W9XAN	July 30	A	W6XK
	A	W6XK	Aug. 4	BB	W9XAN
July 7	BB	W9XAN	Aug. 6	BB	W6XK
July 9	BB	W6XK		A	W9XAN
	A	W9XAN	Aug. 7	HX	W6XK
July 10	BX	W6XK	Aug. 8	C	W6XK
July 11	C	W6XK	Aug. 13	A	W6XK
July 16	A	W6XK	Aug. 20	B	W9XAN
July 23	B	W9XAN		B	W6XK
	B	W6XK	Aug. 25	C	W9XAN
July 28	C	W9XAN	Aug. 27	B	W9XAN
July 30	B	W9XAN		A	W6XK

STANDARD FREQUENCY SCHEDULES

Time (p.m.)	Sched. and Freq. (kc.)		Time (p.m.)	Sched. and Freq. (kc.)	
	A	B		BB	C
8:00	3500	7000	4:00	7000	14,000
8:08	3600	7100	4:08	7100	14,100
8:16	3700	7200	4:16	7200	14,200
8:24	3800	7300	4:24	7300	14,300
8:32	3900		4:32		14,400
8:40	4000				

Time (a.m.)	Sched. and Freq. (kc.)	
	BX	
6:00	7000	
6:08	7100	
6:16	7200	
6:24	7300	

The time specified in the schedules is local standard time at the transmitting station. W9XAN uses Central Standard Time, and W6XK, Pacific Standard Time.

TRANSMITTING PROCEDURE

The time allotted to each transmission is 8 minutes divided as follows:

- 2 minutes—QST QST QST de (station call letters).
 - 3 minutes—Characteristic letter of station followed by call letters and statement of frequency. The characteristic letter of W9XAN is "O"; and that of W6XK is "M."
 - 1 minute—Statement of frequency in kilocycles and announcement of next frequency.
 - 2 minutes—Time allowed to change to next frequency.
- W9XAN: Elgin Observatory, Elgin National Watch Company, Elgin, Ill., Frank D. Urie in charge.
W6XK: Don Lee Broadcasting System, Los Angeles Calif., Harold Perry in charge.

Schedules for WWV

For transmissions and schedules of standard time intervals and ionosphere bulletins see "WWV Services Again Expanded," June, 1937, QST.

Each Tuesday, Wednesday and Friday (except legal holidays), the National Bureau of Standards station WWV will transmit on three frequencies as follows: 10:00 to 11:30 A.M., E.S.T., 5000 kc., noon to 1:30 P.M., E.S.T., 10,000 kc., 2:00 to 3:30 P.M., E.S.T., 20,000 kc. On each Tuesday and Friday the emissions are continuous unmodulated waves (c.w.); and on each Wednesday they are modulated by an audio frequency. The audio frequency is 1000 cycles per second.

Heard on the 14-Mc. 'phone band (by W2LXY): "Well, if you are 4 kc. lower in frequency than I am you must be way out of the band, as I am on 14,149 myself."!!

W8QJH, 119 Forest St., Wellington, Ohio, is interested in hearing from amateurs who like to play checkers by radio. He has his station equipped with break-in and is ready to take on all comers. His frequencies: 3735-kc. c.w., 1817-kc. 'phone.

IN ALL IMPORTANT INSTALLATIONS will be found C-D DYKANOL FILTER CAPACITORS



THE OUTSTANDING characteristics of the C-D Dykanol impregnated and filled, types TJ and TL capacitors have made them famous with engineers and amateurs everywhere. Atmospheric conditions and adverse temperatures have no effect upon their electrical characteristics. They are hermetically sealed in non-corrosive containers. Further the high dielectric strength and constant of Dykanol has made possible the construction of these capacitors, fully 60% smaller than previous types.

For complete data write for catalog 137A free on request

MICA ■ DYKANOL ■ PAPER
WET AND DRY ELECTROLYTICS

TYPE TL





UHX-10R TRANSMITTER

with Remote Control

SPECIAL MOBILE INSTALLATION
for AUTOS • TRUCKS • BOATS

featuring— 1500-60,000 Kc COVERAGE
CRYSTAL CONTROL to 42 MCS.
"PUSH TO TALK" OPERATION
LOCKED TUNING CONTROLS
SHOCK PROOF MOUNTING
CALLING TONE

Photos at left show UHX-10R Transmitter installation. Above: controls on dash. Below: Transmitter mounted in trunk compartment at rear.

Send for information and prices

HARVEY RADIO LABORATORIES, INC.
12 Boylston St., Brookline, Mass.
Export: 25 Warren Street, New York City. Cable: "Simontrice"

IMMEDIATE DELIVERY ON THE UHX-10 TRANSMITTER
SPECIAL LOW DOWN PAYMENTS AND TERMS ON ALL HARVEY TRANSMITTERS
UHX-10 DOWN PAYMENT ONLY \$7.00
DELAWARE RADIO SALES CO., WILMINGTON, DELAWARE
WILLARD S. WILSON — W3DQ

Gone Like the Wind!

are all your mathematical problems with these **LIGHTNING CALCULATORS**. Flip a dial, take a turn, set the indicator, take a deep breath — and there you have it!

Type A, \$1.00
For problems involving frequency, inductance and capacity, in design of radio frequency circuits. Direct reading answers for size of coils and condensers for any range between 400 kc. and 150 mc.

Type C, \$.50
More information on electrical conductors than you could find in a book full of tables.

Type E, \$.50
Direct reading total resistance of resistors connected in parallel, and total capacity of condensers connected in series.

Type B, \$1.00
Gives direct reading answers to calculations involving current, resistance, voltage and power with scale for resistance of copper wire and scale for calculating decibel gain or loss.

Type D, \$.50
Gives decibel gain or loss when input and output voltages, currents or power are known.

Type F, \$.50
Permits measurement of resistance, from 1 ohm to 1 megohm by use of a voltmeter. Makes an ohm-meter of your voltmeter.

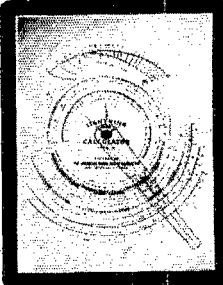

swish!

PRICES INCLUDE POSTAGE FROM THE AMERICAN RADIO RELAY LEAGUE

(Continued from page 89)

sisted by the new RME69, 3BUI made W.A.C. in the DX contest after trying since 1931. 3EON is building a model Vibroplex. 3GES is completing his 211 final. 3CZS has been looking without success for W10XGY and WORG. SRQ moved to Williamsport. 2GUD is a new ham (16 years old) and is all set to explore 7 and 56 Mc. 8PCL made over 3000 points in the last O.R.S. party. 2ITX/3 is ready for summer vacations. 3EWJ enjoyed the Williamsport Hamfest. 3CXE broke down his Class B transformer and replaced it with a new VM-4. 3EFP rebuilt his rig and bought a new NC-100X receiver. 3EDC had lots of fun during O.R.S. party. 3EZ bought a new SW3-d.c. model for portable and emergency use. 3CHH worked a W4 in Alabama while using 10 watts 'phone on 28 Mc. 8ASW enjoyed the Williamsport Hamfest. 3IU is settled in his new location and threatens his brother O.P.S. with some real competition. 3FPW is new editor of Beacon Radio Amateur Club paper, "Parasitics." Ed suggests 3RGO and 3BER for O.R.S. 8FLA is having lots of fun and some real performance from his new HERO receiver. 3DGC found time for two long rag chews to make a couple more R.C.C. members. 3ADE mentions that 28-Mc. activity continues brisk in Harrisburg Section. 3QP hooked his first K7 and had a fine QSO. 3ETM offers his help toward clearing East Penna. traffic. 3BRZ enjoyed the last O.P.S. party, but wonders if something couldn't be done about those outsiders who were deliberately causing interferences. The answer is "Yes." Report exact details to League Headquarters. A telegraph complaint to the nearest F.C.C. monitor station is also effective if other methods fail. Congratulations to 3MG who has moved to Chocopee Falls, Mass., as transmitter test engineer for Westinghouse. His wife Mary (3FXZ) will soon follow. Our Section will miss them. Good luck to both! 3EU signed up for Emergency River Survey. 3AGK is working 56 Mc. for a change. 3CHH and 3DGC applied for O.R.S. 3FVQ (a 1913 ham) applied for O.P.S. 1JFN of A.R.R.L. staff visited several clubs in our Section. The Main Line Radio Club has started its summer series of 1.75-Mc. transmitter hunts and wants to know if any other nearby club dares to compete in its final run-off. How about it, "York Road"?

Traffic: W3QP 579 EOP 325 (WLQB 98) EWJ 275 (WLQH 15) ECA 208 FXZ 179 AKB 168 ETM 98 EDC 48 DGC 47 GMP 30 AQN 27 EML 27 FRV 18 EUP-GLQ 12 ADE 10 GHK 8 GES 7 CHH 6 EZ 5 FPW-BUI 4 EON 3 EFH 2 8FLA 182 (WLQC 47) PCL 14 ASW 12 BQ 9 2ITX/3 58.

MARYLAND-DELAWARE-DISTRICT OF COLUMBIA—SCM, E. L. Hudson, W3BAK, 3CQS, 3CXL, 3EOU; R.M.'s: 3BWT; Chief R.M. After spending 19 months in the Hospital, Ed. Day is out again and will resume work at WLM on June 24th. BWT is building and rebuilding. FRV has a new rig with 35T's final. CDG received a QSL from the Archduke of Austria, OEBAH. EYX expects to have high power on all bands soon. EZH and GEB are rebuilding. FNG finished a rebuilding job. The following items from Bill Brantley of the Washington Radio Club: GLV is building a kw. rig on 56 Mc. FGG is looking for new DX on 28 Mc. RL is rebuilding rig on 56 Mc. FAQ is rebuilding using '03A's. BAS is building u.h.f. 'phone rig. FUT of S.S. Chicago changed QTH. CDQ, Washington's YL opr., is attending the I.R.E. conventions in N.Y.C. On May 8th the Washington Radio Club conducted its last meeting preparatory to closing this year's successful sessions with the annual spring hamfest and elections on May 22nd. The members of the Washington Radio Club wish to express their appreciation to the fine group of officers for 1937: 3ER, Pres.; CYO, Vice-Pres.; I. L. Holmes, Secy.; CZE, Treas.

Traffic: W3CXL 25 (WLM 261) DQ9 97 (WDMC 389) SN 616 BWT 404 CIZ 230 FSP 24 FRV 22 CDG 6 EHW 4 EYX-FPQ 3.

SOUTHERN NEW JERSEY—SCM, Carroll D. Kentner, W3ZX—DQO did special two weeks' duty at the Philadelphia Navy Yard. QL has new QTH: 46 Potter St., Haddonfield. DNU's rig is ready for emergency work. GVO is a new ham in Atlantic City. FXM has made 925 contacts during his first year on the air; he and FBM have competition on to see who can W.A.S. first. BIR plans on complete revision of his receiving and transmitting equipment. ZI reports that the old Delaware Valley Radio Assn. share organized with the following officers: CCO, Pres.; ZI, Secy.; CCC, Vice-Pres.; V, Treas. BEI received a QSL card from the Archduke of Austria. FPA has a new oscilloscope using the new 913 tube. The South Jersey Net has

recessed for the summer after a successful winter season.

Traffic: W3DQO 14 DNU 48 AEJ 11 ZI 76 BEI 5 BO 9 CES 12 BYR 27 FPA 16 ZX 5.

WESTERN NEW YORK—SCM, Charles Smith, W8DSS—R.M.'s: 8JTT, 8BJO, 8AQE, L.O.: 8CSE, P.A.M.: 8CGU. Our Liaison Officer, CSE, leads the Section this month. TZ operated at the Syracuse University Electrical Show, but passed most of the traffic to EWP for further relay. AQE is now at Coyne Radio School. FCG will be on all summer with A.A.R.S. NWZ will enter Cornell Univ. this fall. W2HTX-8 will be back at Cornell next fall with higher power. DHU is busy with N.C.R. The Section extends its deepest sympathies to KXA in the loss of his mother. LUQ applied for O.R.S. QHX is working nice DX. CGU is busy with O.P.S. exams. CYG has returned home after a successful season with his own jazz band in Bridgeport, Conn. QQQ is a new ham in Clayton. MAD passed O.P.S. test OK. BFG is experimenting with antennae. EBR has accepted a position with G.E. in Mass. TZ will work for C.B.S. in N.Y.C. KKR landed a job with Firestone and will be sent to their large rubber plantation in Liberia, Africa. He will be signing EL27 for the next few years.

Traffic: W8CSE 376 (WLMN 54) PLA 244 BJO 241 EWP 119 TZ 127 AQE 89 FCG 78 GWY 73 DSS 72 NWZ 70 FUG 61 PCW 59 DHU 45 KXA 28 CGU 14 LUQ 4 QHX 2 W2HTX-8 55.

WESTERN PENNSYLVANIA—SCM, Kendall Speer, Jr., W8OFO. R.M.'s: 8KWA, 8KUN, 8MOT. Prospective O.R.S.—OKS. Club News: The A.T.A. had a turnout of over 150 at its annual hamfest with Brad Martin, Atlantic Division Director, as guest speaker. The S.H.B.P. & M. meeting of May 25th was held in the KDKA studios and was broadcast over 8XK and XKA. WLMA/8YA B.P.L.'d again with A.A.R.S. traffic. OFO has been receiving more heard DX QSL cards on 3.5 Mc. KWA will operate 'phone during the summer. NDE says the Humdinger Net has closed for the summer. QAN is secretary of the S.H.B.P. & M. LGD got his 6L6 working. CMP attended the Ypsilanti, Mich., Hamfest. GBC is rebuilding for 300-watt c.w. and 160-watt 'phone. KOB has a new Royal portable using all capital letters. YA received a "J" QSL which qualifies them for W.A.C. To celebrate the occasion, Crossley threw a feed; there are twenty-one operators on the YA staff at present. DGL received his W.A.S. New ham: QVU, Monessen. LOR has moved to Bellevue and will operate 7 and 14 Mc. FIP reports that the Penna. Assn. for the Blind is operating 1.75-Mc. 'phone and 3.5-Mc. c.w. with the call QVO. NCJ has been doing some FB DX work hooking OA, HA, G, CM, D4, VK, TI, PY, OZ, etc., he reports working the Finnish S.S. Maria Thorden, SOE8NG. GHT is experimenting with antennae. JSY/4 at Miami, Fla. (with Eastern Airlines), manages to get in some 14-Mc. operating. NUH, rebuilding, will use an 805 final.

Traffic: W8OFO 254 KWA 216 NDE 135 QAN 131 MOT 110 UK 61 LGD 52 CMP 47 GBC 34 KUN 28 KOB 22 AXD 6 YA 5 (WLMA 600). (March-April, UK 133.)

ROANOKE DIVISION

NORTH CAROLINA—SCM, H. S. Carter, W4OG—CYB and CPT have been appointed P.A.M. to assist your S.C.M. in getting the 'phone dope each month. Your coöperation would be greatly appreciated by these men and myself. DGV's daughter had an emergency operation at Gastonia, and CXV kept schedule with DGV every night and kept him informed of her condition. Congratulations, OM. Raleigh: CGL's new rig is capable of from 750 to 800 watts input. DW still holds the title of Champion Message handler, even if he has many other things to occupy his time. EG, JB and ANU have started rebuilding. Salisbury-Spencer: The Salisbury Radio Club has a building and station of its own now. EAM is rebuilding. Lattimore: DGU thoroughly enjoyed the last O.P.S. Party. Warren Plains: BHR is building a new rig using the "Bi-Push" exciter with an 805 final. EIO moved from Kentucky to Warrenton, and is in charge of the Weather Station at the airport. Chapel Hill: CDG moved to Asheville. Morganton: CYB needs Nevada for W.A.S. DSO has his W.A.S.; he is working 14 and 7 Mc. Wilmington: FT is going strong on 28-Mc. 'phone; he relayed a message to Hawaii from BRK. EC is using a pair of T-55's on 28 Mc. BJV has his new 14- and 28-Mc. rig going. BQZ has a Johnson "Q" on 14 Mc. BPL is trying to get his receiver working on 28 Mc. EEL is working on 1.75 Mc. CPT has his rig on 28 Mc. BRK is the guiding light behind the N.C.R. unit. W4BVJ uses a single '45 on 7 Mc. US

is rebuilding his rig for crystal-control. East Flat Rock: EKM sends code practice each Sunday night at 9:00 P.M. Winston-Salem: BYA on 28 Mc. is dividing his time 50-50, rag chewing and experimenting. DGV is working 3.9- and 14-Mc. 'phone mostly. DWB is active in the Army Net, 4NC is planning for Field Day. CFR is active on 7 and 14 Mc.

Traffic: W4DW 80 APT 51 CFR 18 WE 10 EKM 6 CYB-DWB 4 BRK-FT-CXM 2 DGU 1 NC 4.

VIRGINIA—SCM, Charles M. Waff, Jr., W3UVA—GTS acted as N.C.S. in 3rd C.A. in A.A.R.S. for week ending May 17th. DWE is on 14-Mc. 'phone. ELN schedules 6FWJ and K4AAN. GPC schedules FHT. FGJ is rebuilding with T200's in final. FBL is back on in Richmond. UVA worked FY8, HK, YV and EL2M for new countries. CSY took messages for EXQ at Hampton Institute Trade School Exhibit. GBC has 35-T final. AHQ is moving from Strasburg to Staunton. EWW visited GBC. FQY, FKD and EVT applied for O.R.S. FQO worked U9ML for W.A.C. GWG is a new ham in Richmond on 7 Mc. AIJ spends his operating time on 4-Mc. 'phone, but is experimenting with 28 and 56 Mc. as well. BFW is building 1-kw. final with 100TH's in P.P. GFM was in the O.R.S. Party. EXW schedules 3BSY/4 at the University of Florida. AVR is getting out well on 28-Mc. 'phone. The Virginia Floating Radio Club meets next in Danville, Va., on July 18th. This will be a joint meeting with the North Carolina Club, so BE THERE!

Traffic: W3GTS 160 (WLQE 73) CSY 70 ELN 58 UVA 18 FBL 11 FGJ 8 GPC 4 GP 3.

WEST VIRGINIA—SCM, Dr. Wm. H. Riheldaffer, W8KKG—CDV has been going places on 14 Mc., having hooked FY8C and CP3ANE for a total of 70 countries. ASI worked an I for his number 52. KSI is on 3645 kc. MIS is tied up to new 1.75-Mc. outfit. OFO is experimenting on 28 Mc. QBS is now on a farm. NTV likes P.P. 6L6 osc. for low-power work. ONP is on 7 Mc. regularly. ELO is on 3506 kc. most of the time. QBQ has a new final with a pair of 354's. HD is on Trunks "A" and "E" and on National Trunk at 11 P.M. ZW attended I.R.E. Convention. EWM is building portable portables. OLV schedules HD and 3EDC. NAU schedules the Tenn. Net. PQQ is W.A.S. and has a new 354C in his final. BHG is back after a long absence; he has an NC-101X receiver, and a ten in his final. BOK is still on 3.9 Mc. with his Harvey. PZP is on 1.75 Mc. again. JRL is using a signal squirter on 28 Mc. AZD has a new 14-Mc. directional up for Europe. The Huntington Radio Club entertained at a hamfest on May 16th. Lt. G. A. Lincoln gave a résumé of the activities of the Coast Guard in the flood of January. Colonel Clyde Eastman, the Signal Officer of the Fifth Corps area, explained the Army Amateur Radio System. Lt. Loren Windom, Chief Radio Aide, was a visitor. Over two hundred amateurs were present.

Traffic: W8KXC-NTV-AKQ 3 HD 121 QPZ 1 PQQ 6 NAU 14 OLV 35 EWM 2 KYJ 4 MCL 14 CZ 10 KKG 75 HWT 60.

HUDSON DIVISION

EASTERN NEW YORK—SCM, Robert E. Haight, W2LU—EGF is back in the traffic lead. JWT reports KJC new ham in Larchmont. HYC is working in N.Y.C. CC continues his DX records. HCM on 3.9-Mc. 'phone received QSL from Archduke of Austria. QY on June 27th leaves for Arctic for 15 months with radio gear. E.N.Y. extends best wishes for a bon voyage to Jerry. ITK reports HUB blowing snap switches with 1500 volts. BDB has spiffy ground-wave antenna. KKN is station at Kingston National Guard Armory. CJS is wielding a paint brush instead of the key. ACB reports past month's visitors: 8CMP, Dr. Woodruff; 9VXZ; 8CHU and 8ADV. HNH is trying 56 Mc. CJP is member of 330 Club; 8MCT is control station of Club. IOU reports KLG newest ham in Portchester. HJX is ham afloat on board U.S.S. *Mississippi*. FBB is on 7 Mc. with new 100-watt rig. JJS requests O.R.S. appointment. KBT finally got the bugs out of his new 60-watt c.c. 14-Mc. rig working YR5TP with an S7. Mid-Hudson Amateur Radio Club news: GWW and GFD devote their time mainly to 56 Mc. DOS works 3.5 and 7 Mc. frequently. CVT completed new transmitter using pair of T-20's in last stage. CGT changed QTH; is now living two or three miles out in the country. AXX, old-timer, is getting back on the air. BJX is on 7 Mc. renewing old acquaintances. AEQ is rebuilding. KGU uses low power but gets out OK on 7 Mc. HES and HVS, who work nights in local theaters, do most of their operating in the mornings. JGQ, operator at the Department of Commerce Airport, New Hackensack (five miles east of Poughkeepsie), and an active 3.9-Mc.

'phone man, joined Mid-Hudson Amateur Radio Club.

Traffic: W2EGF 245 JWT 100 ISQ 109 LU 54 HYC 22 CC 4 HCM 2.

NEW YORK CITY AND LONG ISLAND—SCM, Ed. L. Baunach, W2AZV—New O.B.S.: JGC, JHB and KBG. O.O.: HYL. Out for O.P.S. appointment: ITS, JDF and JUX. CSO sends his report from Canal Zone; he can be heard operating on 500 kcs. commercial. HLI, IZJ and JHB are getting ready for Field Day using a 6L6 with 15 watts input. IPB is operating on 56 Mc. from Fisher's Island, N. Y. OQ is building three power supplies and 807 Tritet oscillator. EYS needs Asia for W.A.C. HGO contacted the Yacht Vara bound for Florida. ELK is looking for a schedule with California on 7 Mc. PF is experimenting on 3.5- to 14-Mc. cross-band operation, with A.A.R.S. members and BN. FF is rebuilding his modulator unit. JFP is at his Ramensburg QTH. ITX sends his last report from college until September. HMJ finally made the R.C.C. DOG found that his 42-foot mast just gave enough material for his babies' play pen, so the mast is no more. JGF, KAM and KIX send their first reports. JGF is on 7195 kc. using 6L6, with 20 watts input and HRO receiver. KAM is on 7032 kc. using '47 crystal oscillator, 5 watts input and is trying for W.A.S. KIX got his ticket April 2nd and worked his first station the same day. HLI has a new Super Sky-rider. EGL and GQC have new Sky Challengers. IMW has been changed to 3GVD, Washington, D. C. New calls in Brooklyn: KIU and KJQ. JLW replaced his final stage with a pair of tens; he can be heard working break-in with KLE on 28 Mc. AZV's new celotex shack is beginning to take shape. BYL is using low power pending the construction of the high-power rig. HWS graduated from school. JBL is going to college next fall. KGN is on 3.5 Mc. with 2A5 e.c. oscillator and '46 final. IVY has his antenna problems. KAJ is on 1.7-Mc. 'phone using a ten in the final. DQW schedules K5AA. BGO schedules 8FJN. The Tu-Boro Radio Club publishes an FB bulletin for its members. ADW is now with R.C.A. at Riverhead after doing a long stretch with the mailboat service.

Traffic: W2DQW 225 BGO 141 JBL 114 PF 87 ITX 58 OQ 47 AZV 38 EYS 25 JFP 16 JHB 14 HGO 10 FF-BKP 9 AA-HJT-DLR 8 IED-ENS-JRC-BFA-FLD-HBO-HMJ 6 BYL-JGC 3 AHC-DOG-HYL-AVS-GG 1 DBQ 187 (WLNB 83).

NORTHERN NEW JERSEY—SCM, Fred C. Read, W2GMN—The Original Tri-County Radio Association had its annual election on May 3rd. New officers are: Pres., CAY; Vice-Pres., BYD; Treas., HVK; Secy., FOI. The club meets Monday evenings at the Rahway Y.M.C.A. Visitors are cordially invited. CAY is building a crystal-controlled rig to operate on all bands from 1.7 to 60 Mc. HVK has a 56-Mc. outfit installed in the car, and asks the fellows to keep an ear open for him. HTX is home from school. HNP has 500-watt input after long struggle. GIZ recently worked VU2CQ on 'phone making him W.A.C. 'phone after having his Class A ticket less than two months. Good work, Carl! JMX expects to have high power soon. BYD's new QTH is Linden, N. J.; he is back on 56 Mc. with crystal-controlled T20's. DPA has 1-kw. input on 14 and 28 Mc. HXI worked 8 VE5's in succession in W/VE contest. HFT worked his first K6 on 7 Mc. EKU and HZR recently vacationed at Atlantic City. GBY uses crystal 'phones for mike and finds them FB. HZY has 211 in final. The Bloomfield Radio Club has transmitter back on 3.5 Mc. HFB likes his new receiver. KKO expects to be on 1.7-Mc. 'phone shortly. KJH reports for the first time. JYK has new RME69 receiver. KDO is on 28 Mc. HLC is building a 1-kw. transmitter for use on 14-Mc. 'phone. HXI is planning to attend college in the fall. IAP spent a week visiting in Pennsylvania. JUC is experimenting with 1.7-Mc. 'phone. IQM has band-switching arrangement for three bands; he can QSY in 5 seconds. IYG has new transmitter on 1.7-Mc. 'phone. HQL is building new rack and panel job. JUV has FB remote control system. GDB is back on 1.7-Mc. 'phone. CNU invented new crystal holder which holds a dozen crystals. DOE is still looking for that card from Asia. IBR's final is finally perking properly. EKU has moved to Scotch Plains. FSQ joined the radio section of Essex Troop 102nd c.a. N. J. National Guard.

Traffic: W2BCB 1672 (WLNF 1174) GGE 380 (WLNQ 69) LAP 200 HOZ 140 GVZ 135 HNP 107 HXI 88 IQM 64 HQL 53 (WLNK 41) HTX-8 48 GMN 38 JUC 36 HFT 27 DPA 24 HCO 15 ICJ 15 IZV 6. (March-April, HZY 542 CGG 81 CMC 46 FOP 34.)

COMPLETE STANCOR KIT

4 OSCILLATORS

- Straight Pentode
- Tritet
- Jones
- Bi-Push

2 BUFFER DOUBLERS

- Triode
- Dual Triode

4 AMPLIFIERS

- Single Triode (T20 or Type 10)
- Push-Pull Triode (T20 or Type 10)
- Single Pentode (RK-39 etc.)
- Push-Pull Pentode (Bi-Push) Forty-Eight Combinations

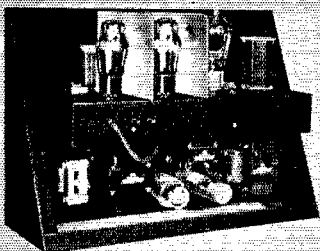

48 CIRCUIT COMBINATIONS

FOR \$49⁹⁵

Here's a natural for the medium-power amateur. 4 Oscillators . . . 2 Buffer-Doublers . . . and 4 Amplifiers . . . 55 to 120 watts input **ALL FROM A SINGLE KIT.** The kit includes circuits on the most recently released tubes . . . and circuits on older types of tubes that you probably have in your shack.

The new Stancor "48-C" Kit contains *ALL* the parts you need FOR EVERY CIRCUIT — less crystal, tubes and meter.

COMPLETE SCHEMATIC BLUE PRINTS FREE WITH EVERY KIT

STANDARD TRANSFORMER CORPORATION

850 BLACKHAWK STREET • CHICAGO

OHMITE POWER-LINE CHOKES

are designed to suppress power line feedback interference of radio frequency. For complete details write for Bulletin 105 or see your dealer.

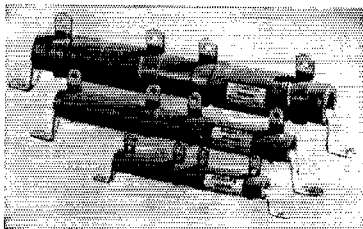

OHMITE MFG. CO.

Rheostats, Resistors and Tapswitches

4831 FLOURNOY STREET

CHICAGO, ILLINOIS

HANDBOOK
PAGES

518-519
CATALOG
SECTION

License or Chart Holder

A HANDY gadget which will dress up the station has recently been brought out for hams. It is a rectangular metal frame, 4½ by 3 inches, provided with pyrolin windows between which a combined station-operator license just fits nicely so that both sides can be seen. The frame is swivel-mounted in a small mike-stand type base for desk use, or in a bracket arm for fastening to a transmitter panel. The finish of the metal parts is black crackle.

The holder comes furnished with graph paper so that calibration curves can be mounted in it, if desired. The holder is made by Gordon Specialties Company, Chicago.

New Tuning Indicator Tubes

TUBE manufacturers seem to be having a lot of fun with electron-ray tubes, judging by the way they vary this and that to get new varieties of tubes with differing characteristics. Two more of them have been announced recently: the 6T5 and 6AB5 (the latter, we think, marking the first advance into "two-letter" tube designations).

The 6T5 operates under conditions similar to those of the 6G5 at 250 volts; that is, the triode section is of the remote cut-off type. The target pattern, however, instead of being pie-shaped is like a doughnut. At zero grid bias the bright portion is a narrow ring around the outside of the target; as the grid voltage increases negatively the bright ring expands inwardly and at maximum grid voltage covers very nearly the whole target. It's supposed to be easier to "read" than the wedge-shaped pattern. The bulb is tubular.

The 6AB5 is a "low-power" tuning indicator for auto sets and the like, working at a maximum plate voltage of 135. The filament takes 0.15 amp. at 6.3 volts. It has the conventional wedge-shaped pattern. Also tubular bulb.

If you want a cathode-ray tuning indicator in your set, you now have your choice of the 6AB5, 6E5, 6G5, 6H5, 6N5, 6T5 and 6U5. Certainly no one can complain about lack of variety!

Strays

The new edition of RCA's Receiving Tube Manual (RC-13), now available, is an expanded version of the former editions of this informative little book. Besides the expected information on the tube types added since the last edition, there is considerable circuit information and a highly-useful and complete tabulation of the operating conditions for various types of tubes in resistance-coupled amplifier circuits. The treatise on vacuum tube operation has been enlarged to include the latest developments. Priced, as before, at twenty-five cents, and can be obtained from the Commercial Engineering Section RCA Radiotron Division, Harrison, N. J.

NEUTRALIZING CONDENSERS

National pioneered the unusual design of these neutralizing condensers. Widespread use has proved the soundness of their principle and the honest quality of their construction. All sizes have both plates insulated by Isolantite, and have heavy aluminum plates machined to a smooth rounded edge.

Three sizes are offered. The smallest (Type NC-800, Net Price \$1.80) is suitable for the RCA-800, EIMAC 35T, 50T and similar tubes. The next larger size (Type NC-150, Net Price \$3.90) is for tubes like the HK-345, RK-36, 150-T, 300-T and 852. The largest size (Type NC-500, Net Price \$7.50) is suitable for the WE 251A and similar tubes.

The chart at the left shows the capacity in mmf. for various settings of the spacing between the plates.

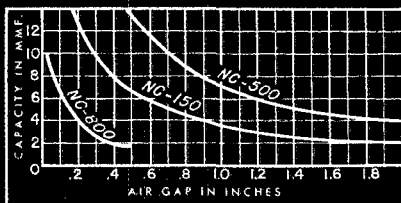

NATIONAL COMPANY, INC.

Radio Operator's
Course

Complete in
Telegraphy—
Telephony



Practical
Experience
Studio—
Transmitter—
Announcing

AVIATION RADIO A new complete training embracing advanced work for amateurs, or operators—twelve months' study required for the average amateur to graduate—excellent opportunity for men interested in commercial airlines. Applicant for enrollment must be high school graduate, or college student. We confer degree—Science of Radio—to graduates of this course. If interested, write for aviation radio details.

P. A. C. is an endowed, educational institution—not privately owned, not operated for profit, college rank maintained. Course consists of maximum knowledge necessary to secure Commercial Telegraph Second-class, and Radio-telephone First-class government licenses. Course includes Wireless Code, Radiophone, Announcing, Microphone-Studio Technique, Service, Television, Police, and Aeronautical Radio. We are authorized to teach RCA texts. At the completion of course you receive practical studio technique experience in our commercial broadcast studios located in the administration building, and experience as an operator on K P A C (500-Watt Commercial transmitter located on the campus, owned and operated by the college), and inter-departmental marine communication experience.

If interested, write for Bulletin R

PORT ARTHUR COLLEGE ■ PORT ARTHUR (World-known port) TEXAS

\$100 for a RADIO KEY!?!?

WORTH IT—but I only charge \$9.50

This semi-automatic key makes it easy to send! Dot stabilizer equipped. Selected main-spring. Marbleite finish base stays put. Chromium metal parts. Proper height for tireless, rhythmic sending. New 1938 Mac Key only \$9.50. Order Today! Also New Mac Straight Key—best ever—only \$2.50. Write for complete dope on other Mac items of tremendous help to radio ops.

T. R. McELROY—175 Congress St., Boston, Mass.
WORLD'S CHAMPION TELEGRAPHER

QUARTZ CRYSTALS

ALL TYPES. Low Temperature Coefficients. X and Y cuts Holders. Ground to any practical specifications.

Write for complete particulars

Bellefonte Radio Eng. & Mfg. Co.
BELLEFONTE, PA.

VACATION TIME means "FIVE" will be HOT!

DUPLEX TRANSMITTER-RECEIVER UNIT

RADIO TRANS-
CEIVER LABS.

TYPE TR-6A6

- Non-radiating receiver
- 7 tubes — Jensen dynamic speaker
- 6E6 unity coupled oscillator
- 10 watt carrier
- 100% modulation

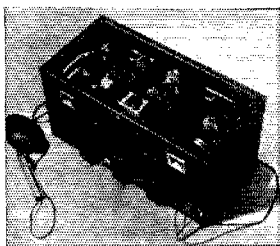

DUPLEX OPERATION — PHONE • MCW

For five meter operation. Also supplied for 30-41 experimental frequencies. Special bands to order. Radio Transceiver Laboratories TR-6A6.....\$39.75
 Complete set of tested Sylvania tubes..... 4.50
 Electronic vibrator power supply — input 6 volts @ 9 amps., output — 300 volts @ 100 mills..... 13.50
 Stromberg-Carlson single button hand mike..... 4.95
 Complete for mobile operation.....\$62.70

ANOTHER POPULAR HI-FREQ. TRANSMITTER

TYPE HFM

- 5 & 10 meter mobile phone
- 20-40 meter CW
- 10 watts output
- 100% modulation
- Crystal controlled
- Weighs 15½ lbs.

In stock. Write us for technical data and prices

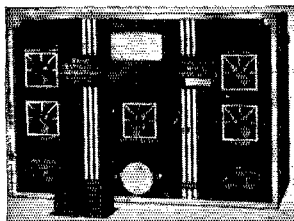

HARVEY UHX-10 TRANSMITTER

- 1,500-60,000 kc.
- PORTABLE
- MOBILE
- PHONE — MCW — CW
- 10 watts output

See this fb rig in our store or write for data.

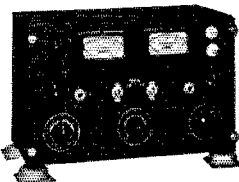

SEE US FIRST — WE CARRY A COMPLETE LINE OF 5 METER EQUIPMENT

● NEW Hallicrafters in STOCK ●

BASSETT CONCENTRIC FEEDER — 100% flexible

50-foot length, net.....\$9.75
 75-foot length, net.....12.75
 100-foot length, net.....16.75

TERMINAL RADIO CORP.

80 CORTLANDT STREET, NEW YORK, N. Y.

BILL FILLER



ADOLPH GROSS

W8DPY Wins Paley Award

(Continued from page 9)

Sleepless for two nights previously, Stiles stayed on the job handling relief traffic continuously for more than 24 hours. When two relief operators arrived from State College, Pa., on Saturday night, he was in a state of nervous collapse bordering on absolute breakdown. In all, he spent 130 hours on continuous duty—without sleep, sustained only by "shots" administered by the doctor who had accompanied the relief party—supplying the citizens and relief agencies of Renova with their sole direct means of communication.

To evaluate Walter Stiles' entire performance is impossible in limited space. That through his efforts the 4000 citizens of Renova were saved untold misery and suffering is only a part of his accomplishment. Through his efforts they were fed, clothed, and protected from the dangers of disease and exposure. It can be said that he was prepared for the emergency; he recognized the need; he demonstrated incredible degrees of perseverance and technical ingenuity, as well as fortitude and courage, in fulfilling his duty as he saw it.

But let's not allow this "hero" stuff to go too far. W8DPY is far from the typical self-seeking "hero" of bad repute; he is, in fact, a real all-around ham of the finest type, as the A.R.R.L. Hq. grand discovered when we had the pleasure of entertaining him in Hartford for an afternoon and an evening following the magnificent Columbia luncheon.

Now 24, he has been a licensed ham for 10 years. He started in radio at the age of 10, when he sold garden seeds to provide the money for a crystal receiver. Four years later he passed the exam and got on the air with a '45 and 4 watts output. By 1933, at 20, he had worked 72 countries and laid the foundation for a real ham layout. Now he is Pennsylvania Net Control station in the A.A.R.S. and technical editor of the "Mason Dixon Straddler," 3rd C.A. publication.

His ham shack is located in an extension built on the rear of his home at Coudersport. Some time ago he acquired a hundred acres of mountain-top land for antenna experimentation, and now has, among other little trifles, an 8-wave-length 14-Mc. diamond with an 1800-foot feeder! He has a well-equipped layout operating on all bands, and as for the new portable set-up—but that's another story. Besides amateur radio, his hobbies include a miniature railroad—he is employed as electrician on the Pennsylvania Railroad—complete with passenger and freight engines, modeled after full-size P.R.R. originals. He also had a stamp collection and is a bug on photography.

In other words, he's a thoroughgoing ham and a right guy, and we can be proud that he has been chosen to typify the best in amateur radio for the year 1936.

—C.B.D.

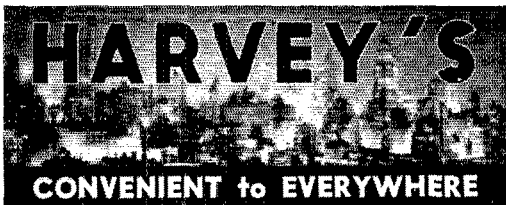

CONGRATULATIONS TO EARL ANDERSON FOR DESIGNING SUCH A FB 3 STAGE ALL BAND TRANSMITTER

We predict that this rig will soon become one of the most popular on the Ham Bands. We have prepared the parts for this rig exactly as specified and pictured on page 22 June QST. The price is amazingly low for a fine transmitter like this since we furnish the specified Cardwell Condensers, complete coil kit as shown, drilled and punched chassis, Sangamo and Cornell-Dubilier Condensers, IRC resistors, National Isolantite sockets, etc. Each circuit is equipped for metering and unit is adaptable to relay rack mounting.

Price Complete, Less Tubes, \$39.95 Complete Kit of Tubes.. \$11.80 Biley LD2 Crystal..... \$4.80

Power Supply Kit for Type 42-T 20 Tubes, Complete... \$9.95 Brush Transfilter in Stock at All Times
 Power Supply for T 55 Complete Kit..... \$18.95 Complete Line of Coto Coils in Stock
 Dumont Oscilloscope and Tubes on Display See the New Hallcrafters Receiver on Display

The Value of the Month

FAMOUS HARVEY TWIN 15 RF KIT

with "Up To The Minute" Improvements. Increased Power, Greater Flexibility, Phone Operation, Antenna Matching Network, etc. A few of the features are listed below.

- Twenty Watts Output on CW-10 Phone
- Built in Resonance Indicator
- Fused against overload
- Crystal Control Regenerative Circuit
- Class A Modulation
- New Beam Tubes in Audio and RF
- Multi-Band Operation from One Crystal
- Full Break-in for CW or Phone
- Highest Quality Parts Thru-out (CD, RCA, BUD)
- Simplified Collins Network — Matches Any Antenna

JUST THE THING FOR SUMMER VACATION WORK

can be used off Mobile with a Genemotor or batteries. Every amateur should have one for an emergency transmitter in case of disaster or as an auxiliary transmitter. May be used to drive a higher power amplifier such as pair of T 20's or T 55's. All parts supplied with drilled and punched chassis. Price less Crystal.

CW..... \$15.95. PHONE, complete with tubes... \$19.95

ANNOUNCING OUR NEW FULLY EQUIPPED CAMERA DEPT. FINEST STOCK — BEST PRICES

OUR *Best* VALUE IS OUR RECORD OF LOYAL SERVICE

HARVEY

Radio Company of New York

103 WEST 43rd STREET • NEW YORK, N. Y.

CABLE ADDRESS: "HARADIO"

The RADIO SHACK

46 Brattle St Boston

SPECIAL OFFERS

Trimmers—Padders

I.F. Transformers

B.F. Oscillators

We have purchased overstock items, consisting of I.F. transformers, beat frequency oscillator units, air trimming and padding condensers, from one of the better known American manufacturers, which we will sell at ridiculously low prices. The name of the manufacturer cannot be mentioned but the units are all trade marked and you will recognize them.

This is unquestionably the greatest bargain in this type of material ever offered to the American Amateur. Quantities are limited. We recommend a quick selection.

AIR TRIMMERS AND PADDERS — SINGLE SECTION

Type No.	Cap.	MMF	Quantity	List	Price
ATS-13-48.....	13-48		216	\$1.50	\$4.48
ATS-5-37.....	5-37		216	1.30	.42
ATS-75-110.....	75-110		189	1.90	.60
ATS-2-7.....	2-7		171	1.10	.30
ATS-34-67.....	34-67		182	1.70	.52
ATS-4-26.....	4-26		206	1.30	.38
ATS-56-90.....	56-90		200	1.90	.56
ATS-3-17.....	3-17		157	1.25	.34

FIXED COUPLING IF DOUBLE TUNED High and medium "Q"

A superior high quality I.F. transformer, tuned by means of a high precision variable air condenser mounted on finest Isolantite base.

Type No.	Freq.	Connection	Quan.	List	Price
FDI 175	175 K.C.	Inter-stage	100	\$4.50	\$1.67
FDD 175	175 K.C.	Diode	100	4.50	1.67
FDD 456	456 K.C.	Diode	5	4.50	1.67
FDMI 465	465 K.C.	Inter Med. "Q"			
			72	4.50	1.67
FDHI 465	465 K.C.	Inter High "Q"			
			33	5.50	1.87
FDMD 465	465 K.C.	Diode Med. "Q"			
			74	4.50	1.67
FDHD 465	465 K.C.	Diode, High "Q"			
			53	5.50	1.87

FIXED CONDENSERS I.F. — TRIPLE TUNED LINK CIRCUIT

FTD — 456 456 K.C. Diode \$5.75 \$1.94

BEAT FREQUENCY OSCILLATOR AIR TUNED

Consists of an efficient coil winding and a very high quality air dielectric variable condenser of precision mechanical construction.

Type No.	Frequency	Quantity	List	Price
BFO — 456.....	456 K.C.	278	\$4.50	\$1.50

Send in your money order or check with your order

ALL ITEMS IN OUR JUNE QST AD IN STOCK — DID YOU GET DOPE ON THE UHF6 SUPERHET?

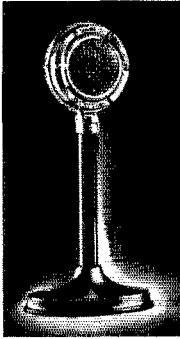

... now 5 db HIGHER OUTPUT

The new Shure 70SW "Communications-Type" Crystal Microphone . . . a new "70S" with 5 db higher output, at no extra cost! Produces clear, strong speech signals . . . requires only 56% of the amplification previously needed!
Model 70SW — List Price, as illustrated at the left, only **\$25**

NEW MODEL 703S

A new deluxe "Communications-Type" Crystal Microphone—smaller, lighter, with a new convenient swivel head. Gives you the famous "70S" DOUBLE-POWER on important speech frequencies. List Price, with desk mount and cable. **\$27.50**



See Your Jobber, or Write for Complete Information—Today!
Licensed under patents of the Brush Development Company.
Shure patents pending.



SHURE BROTHERS
222 N. MURKIN ST., CHICAGO, ILL. U.S.A.
CABLE ADDRESS: SHUREMICRO
MICROPHONES & ACOUSTIC DEVICES



BIRNBACH INSULATORS ARE SPECIFIED BY LEADERS

When leading designers lay out their new rigs they naturally specify parts that can "stand the gaff" yet are priced right. It's no wonder, therefore, that most designers specify Birnbach because Birco products give you the highest possible quality at the lowest possible price.

Improved Cone Standoff Insulators

Made of STEATITE, the better ceramic. Complete range of heights. Condenser, coils, tube sockets, etc., can be mounted with minimum labor. White glaze.

No.	Heights	List
No. 430	3/8"	10c
No. 431	1"	15c
No. 431J	1"	20c
No. 432	1 1/4"	20c
No. 432J	1 1/4"	25c
No. 433	2 1/4"	25c
No. 433J	2 1/4"	50c

NEW TRANSMITTING SOCKETS

- Side Wiping Contacts No. 434. 50 watt
 - Brass, Nickel Plated Shell \$1.25 List ea.
 - Highly Vitrified, Low Absorption Base No. 435. 10 watt
 - All Brass Hardware ● Low Prices 90c List ea.
- SPECIAL LOW PRICES in Large Quantities

BIRNBACH RADIO CO. INC.
145 HUDSON ST. BIRCO NEW YORK, N. Y.

Recording Ultra-High-Frequency Signals over Long Indirect Paths

(Continued from page 18)

used. The only other likely source of trouble is in the r.f. amplifier stage which, by the way, is mounted on the chassis with the tube underneath and its plate circuit above the chassis enclosed in a National shield can. The important adjustments here are the location of the grid taps on the coils L_2 and L_3 . These taps should be adjusted until there is no sign of regeneration in the r.f. stage. Of course, if bypassing has not been done effectively in the immediately-associated circuit, the taps will have to be carried so far down in order to realize this condition that the gain of the stage will be seriously impaired. The usual fiddling with bypass condensers in power supply leads will be necessary in order to stabilize the i.f. amplifier. The two condensers C_{10} were found to be essential in this particular set-up.

A refinement which will be found almost essential if the receiver is to be calibrated for quantitative work is a Faraday shield between the antenna coil and the grid circuit of the first tube. Such a shield may be simply made by winding a coil of about No. 24 d.s.c. wire on a celluloid form, doping it well, then splitting the coil, baring the severed wires at one end and soldering them to a grounding strip. The antenna coil in this case should be made in the form of a thin pie.

Another essential accessory is a voltage regulator for the power supply. We use the Delta voltage regulators and find them eminently satisfactory. Yet another essential with any but very low-drift crystals is an effective constant-temperature oven. The Bliley BC6 type oven has solved the problem for us.

THE RECORD ANALYZER

In any recording work it is one thing to pile up a mass of recordings and to study them superficially. It is quite another thing to work up the records into some form suitable for correlation work. With the early photographic records of hourly tone signals this merely involved measuring off the magnitude of each "pulse," then getting means for each day or part of a day and the means for each hour of the day each month. The advance to continuous recording meant that a reduction of the records to give mean values, done in the conventional graphical manner, would take almost as much time as was consumed in the making of the original records. The need for some short-cut method led to a three-way rag-chew between Harner Selvidge, of Harvard University, Ed Sanders of WTIC and the writer. The outcome was a plan to use a bunch of clocks arranged as a primitive electro-mechanical integrator and operated by a series of thyatron from the output of the receiver. This weird concept was christened at the time "noctagirlcomptometuntimer" because it would probably do the work of eight girls, at the same time failing completely to tell the time in spite of its nine perfectly good electric

TESTED and OK'd for PRECISION LAPPING

THE activity of a quartz crystal is a relative measure of the ease by which it can be excited and its ability to start oscillating. Maximum activity is obtained only by properly cutting the crystal from the raw quartz and then by carefully lapping the faces to an extremely high degree of planeness and parallelism.

To meet these rigid requirements, Bliley Engineers found it necessary to develop specialized machinery for precision lapping. As a final check each crystal is examined by means of a sensitive electrical micrometer gauge and the faces must be within very close limits of being plane and parallel before receiving the inspector's approval.

When you buy Bliley, you are getting the result of the finest possible engineering and production skill and workmanship. When you buy a Bliley LD2 Crystal Unit (40-80-160 meters) at \$4.80, you are getting the best all-round mounted crystal for amateur use. Bliley Electric Co., Erie, Pa.

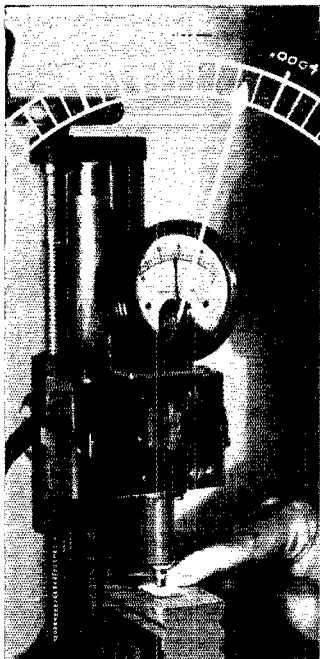

BLILEY CRYSTAL UNITS

LEARN CODE RIGHT

Tapes for Every Need — Even Airways — Send You Typical Messages by INSTRUCTOGRAPH

It's easy and practical to learn or improve your Radio or Morse Code, any speed. Senior model with 10 tapes and Book of Instructions — \$20.25 (Rented at low cost) Junior model with 5 tapes and Book of Instructions — \$12.00. (Not rented). Complete oscillator equipment, less battery, \$5.20. Write for details today.

INSTRUCTOGRAPH CO., Dept. Q-7
912 Lakeside Place Chicago, Ill.
Radio College of Canada
863 Bay St., Toronto

WE ALSO HANDLE: HALLIGRAFTER AND R.M.E. SHORT WAVE RECEIVERS — MICROPHONES — VI-BROPLEXES — TAYLOR TUBES... CASH OR TERMS



RADIO ENGINEERING



RCA Institutes offer an intensive course of high standard embracing all phases of Radio. Practical training with modern equipment at New York and Chicago schools. Also specialized courses and Home Study Courses under "No obligation" plan.

Illustrated Catalog on request

RCA INSTITUTES, INC. Dept. ST-37

75 Varick St., New York 1154 Merchandise Mart, Chicago
Recognized Standard in Radio Instruction Since 1909

Quicker than a short circuit **Littelfuse**

Increase the efficiency of your equipment by using INSTRUMENT LITTELFUSES. All types of fuses and mountings from world-famous factory. HI-VOLT LITTELFUSES for transmitters, etc., 1,000, 5,000 and 10,000 volt ranges, 1/16 amp. up. INSTRUMENT LITTELFUSES for meters 1/200 amp. up. RADIO FUSES, AUTO FUSES, etc. You should know about Littelfuses. See your dealer or write for catalog.

LITTELFUSE LABS. 4246 Lincoln Ave. Chicago, Ill.

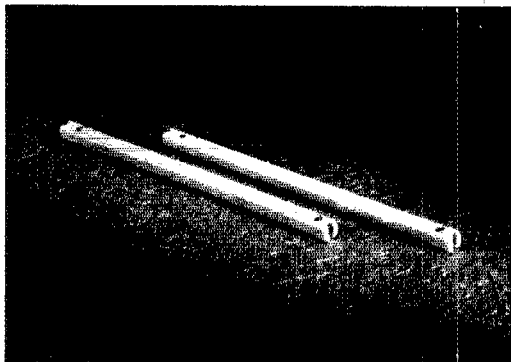

SPREADER: Light in weight as well as exceptionally efficient, these NATIONAL spreaders offer unusual advantages. The material is non-hydroscopic and weatherproof. The slender shape minimizes surface leakage. The power factor is of the order of 0.15%. The weight is but one ounce each. Catalog Symbol AA-3.

Net Price \$18

NATIONAL COMPANY, INC.
MALDEN, MASS.

FIVE METERS

SUMMER TIME • VACATION TIME
TAKE A FLING AT 5 . . . with the
JOHNSON 5Q

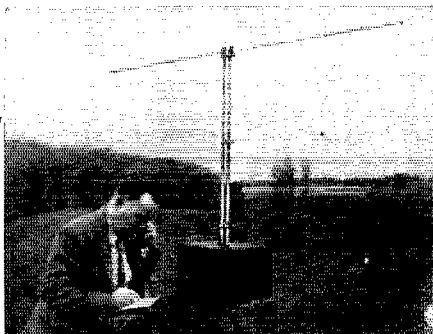

Many secrets remain on 5, but it's no secret that the JOHNSON 5Q is extremely effective on 56-Mc. **Compact, easily set up and taken down, it provides nearly 100% transfer from transmitter to antenna.** May be mounted on set or fed with conventional transmission line, yet this **highly efficient antenna is very inexpensive.**

Available at leading Jobbers everywhere

E-F-JOHNSON COMPANY 
MANUFACTURERS OF *Radio Transmitting Equipment*
• WASECA MINNESOTA U.S.A.
Export Office: 25 Warren St., New York. Cable: "SIMONTRICE"

clocks. The idea was later reduced to practical terms and applied to the more urgent problem of analyzing the seven months of continuous records that had already been made. The final equipment is shown in Fig. 5. It consists of a simple frame made of 2-inch by 1-inch pine supporting a drive roll similar to that used in the recorder. This roll is driven by a phonograph motor at a speed of sixty or more times the speed at which the original record was made. Mounted above this drive roll is a sliding contactor similar to the slider used in the dark ages on single-slide tuners. This slider makes contact with a strip of copper segments cut according to the receiver calibration in 5 db steps. When the pointer on the slider is located anywhere in the region up to 5 db above zero level the contact with the first of these segments closes one of a bank of relays and starts the first clock. With each progressive 5 db in the setting of the slider an additional clock is started until the maximum-signal position is reached. At this time all clocks are running. In operation the record is run through and the pointer on the slider is held manually on the trace on the recording. At the end of any period the drive motor is switched off, the slider set to zero and the new settings of the clocks read off. Comparison of these readings with that of a master clock which runs all the time enables the operator, with a simple computation, to determine the percentage of time for which the signal had been riding at any level. These data are then ordinarily plotted to give a curve of signal level versus percentage of time.

For convenience in taking curves of the diurnal variation in signal level additional dials having one hundred divisions were made up photographically and cemented to the clock faces. For this work the analyzer was run for one-minute periods (corresponding to one-hour periods on the recording) and the percentage of time for each level read off directly from the one-hundred-degree dials.

The actual mechanical and electrical arrangements of the device may, of course, be varied to suit the individual worker. The limitations of space forbid us to offer more than the basic idea.

In order to allow simultaneous recording and analysis of the record the contact strip is mounted on the frame of the Leeds and Northrup recorder, the contactor being attached to the pen assembly. The same relays and clocks are, of course, put to work. The only disadvantage of this set-up is that it requires hourly reading of the clocks if diurnal characteristics are to be plotted. At the moment we are engaged in designing a crude camera, operated from a time switch and arranged to take a picture of the clocks every hour. With this gadget installed it will be possible for us to engage without interruption in our ordinary ham work, happy in the knowledge that when the time comes for an analysis of a few months records we will only need to read off a couple of thousand clock photographs and compute the percentages of time.



NEW HOLDER DESIGN
15 SECONDS TO
INSTALL CRYSTAL

For All Bands
GREATER STABILITY
Plugs in 5 prong tube socket

Beautiful Appearance

MODEL AH HOLDER \$1.00 At your dealer or direct

HIPOWER LOW DRIFT CRYSTALS:
within 10 kc. or Choice of stock

AH-10, 1700-3500 Kc. bands \$2.35
AH-10, 7000-7300 " band 3.90

WRITE FOR NEW LITERATURE

Hipower "Low Drift" Broadcast and Commercial
Crystals Are Approved by F.C.C.

Hipower Crystal Co., 2035 Charleston St., Chicago

We are now delivering
the 1937 Patterson

PR-15

One of the finest amateur and communications receivers ever built.

The PR-15 contains the essential elements found in other receivers plus a long list of exclusive PR-15 features including:

Radically Different 100% Noise Silencer

Automatic threshold control silencer that greatly reduces noise interference from autos, power leaks, heating pads, key clicks, motors, etc.

Crystal Filter, Series and Parallel
Exclusive shielded design — absolute single signal — calibrated. Perfect quality on phone.

Five Bands — 8 to 550 meters — .35 to 40 Mc.

Equal gain over entire range — no dead spots. 2 r.f. stages on all bands. Quiet 10 meter reception.

No Decrease in Signal Strength when Using Crystal Filter and Noise Silencer

Down Payments and Monthly Payments as low as **\$12.50**

SEND 3c IN STAMPS FOR COMPLETE INFORMATION

DELAWARE RADIO SALES COMPANY

WILLARD S. WILSON—W3DQ

405 DELAWARE AVENUE

EASTERN DISTRIBUTORS

WILMINGTON, DELAWARE

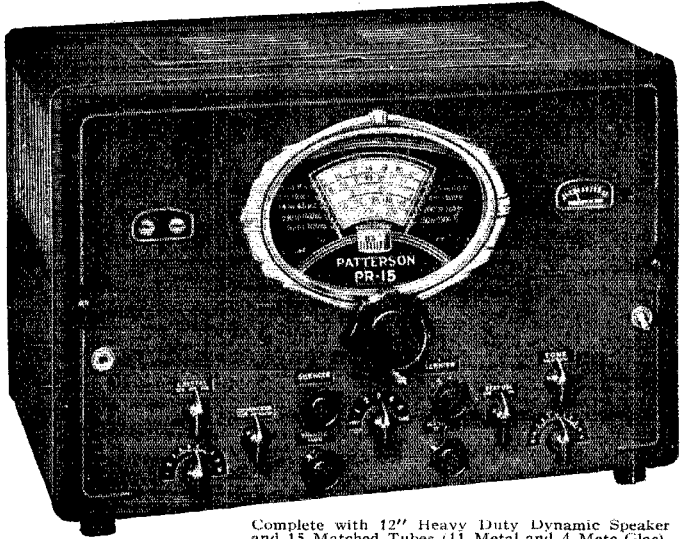

Complete with 12" Heavy Duty Dynamic Speaker and 15 Matched Tubes (11 Metal and 4 Meta-Glas). List price, \$182.50 — Amateur net price,

\$109.50



KENYON



EFFICIENT



RELIABLE



MODERN

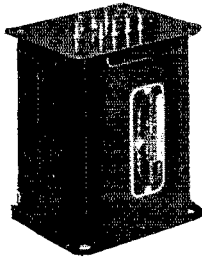

KEN-O-TAP

The Practical Solution to the Modulation Problem

KEN-O-DRIVE

The Modern Answer to Critical Driver Operation

KEN-O-DYNE

The Precision Method of Matching Output Tubes to Speakers

Ask Your Dealer for Our 16 Page "T" Line Catalog Which Contains a Large Selection of Modern Audio Circuits.

Kenyon Transformer Co., Inc.
840 Barry Street, New York, N. Y.
Export Dept.: 25 Warren Street, New York, N. Y.

"And Now We Have Full-Range Superhet Selectivity"*

Stability of a superhet is dependent upon the quality of the condensers and coils used in the circuit! SICKLES coils and condensers are known world-wide for their quality and performance.

We are in a position to supply coils and condensers necessary to construct the "Translater Circuit" described in *QST*, June '37, pages 16-21, by Mr. James J. Lamb. Air Trimmers used are our own design — compact, dependable, and efficient.

Fixed condensers are the new Sickles SILVER-CAPS, the condenser having less than 0.002%, per degree drift.

The coils — the highly efficient "Diamond Weave."

Sickles No.	QST No.	Type	Price
54601	T-1	Input	\$4.25

This unit includes the coils T-1 Air Trimmer C-1 and 2 SILVER-CAPS C-3 Unit complete in shield.

Sickles No.	QST No.	Type	Price
54662	T-2	Output	\$3.75

Unit includes coils T-2 Air Trimmer C-5 complete in shield.

Sickles No.	QST No.	Type	Price
54663	T-3	Input	\$4.00

Unit includes special coils T-3 Air Trimmer C-1 complete in shield.

Sickles No.	QST No.	Type	Price
54664	T-4	Output	\$3.75

Unit includes Coil T-4 and Air Trimmer C-5 complete in shield.

Other items for the Unit can be supplied as follows:

C-1 Bandwidth Condenser — ATR98	\$1.20
C-2 Phasing Condenser — ATR66	1.00
C-3 Silver-Caps Double Unit	1.00
C-4 Output Coupling Capacity — ATR98	1.20
C-5 Output Transf. Tuning Cond. — ATR808	1.45

All above items carried in stock. Order shipped same day as received.

THE F. W. SICKLES CO.
300 Main Street Springfield, Mass.

* See *QST*, June '37, p. 16.

More and More GOOD TUBES have SPEER GRAPHITE ANODES

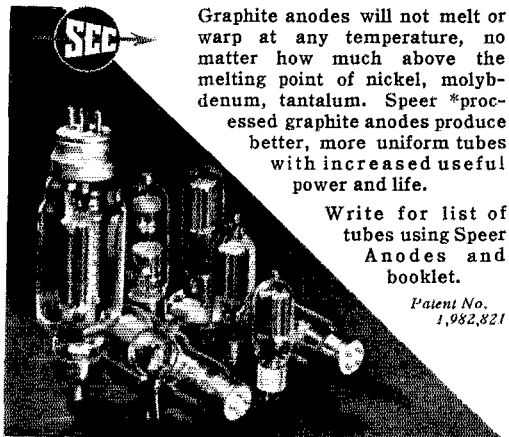

Graphite anodes will not melt or warp at any temperature, no matter how much above the melting point of nickel, molybdenum, tantalum. Speer *processed graphite anodes produce better, more uniform tubes with increased useful power and life.

Write for list of tubes using Speer Anodes and booklet.

Patent No. 1,982,821

SPEER CARBON COMPANY
ST. MARYS, PA.

7-16



TRIPLE TUNED I-F TRANSFORMER

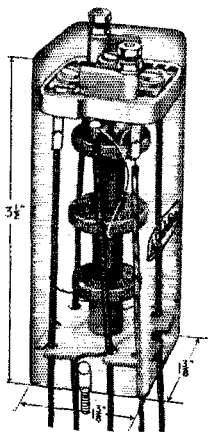

High adjacent channel rejection 30 kc. wide at 20 times down

Broad flat top — 8 kc. wide

Easy alignment; no cathode ray oscilloscope necessary

All trimming condensers tuned from top of shield

Compact Size

N 101 I-f Transformer, 465 kc. conv. \$3.50 List
N 200 I-f Transformer, 465 kc. diode 3.50 List

ALADDIN RADIO INDUSTRIES, INC.
466 q W. Superior Street, Chicago, Ill.

Licensee of Johnson Laboratories, Inc.

Fundamental-Reinforced Harmonic-Generating Circuit

(Continued from page 15)

is carried through any of these harmonics, and power output can be taken from each harmonic. Because the plate circuit of the harmonic generator is coupled back to the crystal oscillator, it is not desirable to couple the load directly to the tank circuit of the harmonic generator, and a coupling condenser is therefore recommended. This coupling condenser is made variable to control output and loading.

Other coupling arrangements than that indicated in Fig. 1 are possible; for instance, the two coils might be link-coupled. This would offer the possibility, with plug-in coils in the harmonic-amplifier plate circuit, of having an individually-adjusted link on each so that the proper coupling would be established when the coil was plugged in.

Regeneration or a tendency to self-oscillation is prevented in the harmonic generator tube because of the by-passing effect of the tuning condenser across the plate coil of the crystal oscillator, and no trouble will be experienced on that account. The circuit is so stable that grid-leak or cathode bias may be used in the harmonic generator; however, battery bias is preferred since it protects the tube in case the oscillator stops. The tube is to all intents and purposes a Class-C amplifier and the same protection should be afforded it as any other tube used for that class of service.

Because the circuit will generate all orders of harmonics, care must be used to tune to the proper frequency. The third, fifth, sixth, seventh and eleventh harmonics just won't do in amateur circles, and some means for determining the fact that the fourth or eighth harmonic is being generated must be at hand. A simple way to make sure is to build an old-fashioned absorption wave meter with a small lamp in series with the coil and condenser. With such a means for determining frequency bands, even if only roughly, the amateur is pretty sure just where he is and there will be no danger of a ticket for out-of-band operation. The likelihood of picking the wrong harmonic is of course much greater on the higher frequencies than on the lower, and this should be kept in mind.

The crystal oscillator circuit is one that has been in use here at W1QP for a number of years, primarily because it is easy on the crystal and because full output may be obtained from the tube used. A plate efficiency of 64 per cent for the crystal oscillator is usual, and r.f. crystal current is of the order of one milliamperere for every milliamperere of plate current. The circuit in the cathode lead of the oscillator is tuned roughly to half the crystal frequency; i.e., for an 80-meter crystal, the cathode circuit is on 160 meters. The cathode coil, which may be a 100-microhenry coil for our purposes, is shunted with a 100- μ fd. fixed condenser. The grid resistor should be of the wire-wound type, and is connected between the grid

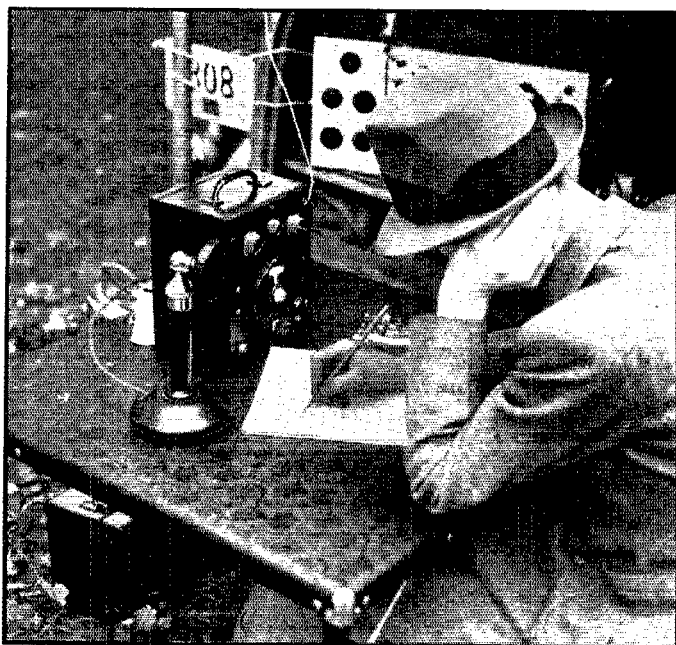

HAVE YOU A LOG

for your
Portable
and Mobile
operation?

35c each
3 for \$1

A.R.R.L.
West Hartford, Conn.

**S
P
E
C
I
A
L**

*See pages
48 and 49*

GULF RADIO SCHOOL

Radiotelegraphy

Radiotelephony

Radio Servicing

SECOND PORT } 1007 Carondelet Street
U. S. A. } NEW ORLEANS, LA.

ORIGINAL UNIVERSAL CLASS B TRANSFORMERS—NOW IMPROVED

MATCH ALL TUBES

50 Watts Audio, Per Pair..... \$4.95 } POST
100 Watts Audio, Per Pair..... 7.75 } PAID

ONE YEAR GUARANTEE

Write Today for Big Free Data Sheet

DOUGLAS RADIO PRODUCTS

BOX A2 DOUGLAS, MICHIGAN
Earl I. Anderson, W8UD

SPECIAL TO AMATEURS

Piezo-Electric Crystals — \$2.50 EACH
POSTPAID

Until supply is exhausted . . . we offer small 80 meter band
crystals unmounted; accurate calibration, excellent oscillators.
Limited quantity.

SCIENTIFIC RADIO SERVICE

"The Crystal Specialists Since 1925." University Park, Hyattsville, Md.

5500 R. R. JOBS FOR CW MEN WHO PREPARE THEMSELVES ■ AVAILABLE SOON ■

No license required. Eight hours per day. Year around. 65
to 80 cents per hour. If you can copy 15 words per minute, write

CODE-CRAFT Q 6703 Dunham Ave.
CLEVELAND, OHIO

A NEW Service TO UP-TO-DATE AMATEURS

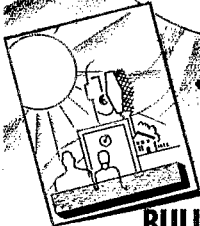

Free!

THESE MONTHLY BULLETINS BRING YOU PRE- PUBLICATION RADIO DEVELOPMENTS

Always among the first with every latest development, SUN RADIO inaugurates a new policy to speed up still further the news of products as fast as they appear. Manufacturers of nationally known standard lines know SUN as the "House of Proven Reliability". They know that here products are honestly described and fairly priced. They cooperate with us because we cooperate with you, the amateur, experimenter and technician! If you want "hot news" of their new products as well as other special Bargain offers every month write now for your Free copy of our first issue just off the Press!

HIGHLIGHTS AT SUN RADIO COMPANY

1. Stancor 40 watt x'mitter complete. Write for literature and prices.
2. Bassett Concentric Feeder. 100% flexible; highly efficient. "50" @ \$9.75, "75" @ \$12.75, "100" @ \$16.75.
3. Thordarson Multi-match class B Transformers. In stock.
4. New Raytheon 6L6G with Octal Isolantite base \$1.95.
5. New Dumont 3" oscilloscope. A trifle higher than 1", complete with tubes \$54.50.
6. New Dumont 2" tube; will replace 913 . . . \$7.50.
7. National HRO, HRO Jr., NC100, NC101X in stock, liberal allowance on your old receiver.
8. Hallicrafters Receivers on time payments; details on request.
9. Hammarlund Super Pro — 10M, Super Pro for immediate delivery.
10. Triplett and Simpson Thermo-couple R. F. Ammeters @ new low price, 3½" diam. — \$6.52.

SUN'S FAST MAIL ORDER SERVICE

To you fellows who find it inconvenient to shop in person . . . try the Sun personalized Buy-by-mail dept. You'll get a real kick out of our super-fast service. We invite your business on "hard to get" items as well as "run of the mill" products. Price? You'll never buy for less elsewhere.

*Intelligent, Personal Service by Trained Technicians
15 Years of Proven Reliability*

RADIO CO.

227 Fulton Street, New York, N. Y.
Cable Address: SUNRADIO NEW YORK

SUN RADIO COMPANY
227 Fulton St., Dept. B7
New York, N. Y.

You bet I want the latest dope on new items as they appear. Put me down for a FREE copy every month.

Name.....

Address.....

City..... State.....

and the cathode end of the tuned circuit. The constants of the plate circuit of the crystal oscillator should be proportioned to give a Q of 12. To determine the proper constants for this Q, reference may be made to the March issue of QST, in which a detailed explanation is given for determining the value of any tuning condenser in terms of the plate input to a tube.¹ On the average, one $\mu\text{fd.}$ per meter is a good value for crystal oscillators.

In the harmonic generator circuit, normal values of grid voltage and grid coupling are used. The grid coupling condenser need not have more than 50 $\mu\text{fd.}$ maximum capacity and it certainly should be variable. The amount of coupling used is determined then by the grid excitation needed for the particular tube being used. For the 807 3 to 5 milliamperes grid current is plenty. As in the case of the crystal oscillator tube, the plate circuit of the harmonic generator should be so designed that it will have a Q of 12 if possible. Should the circuit be built so that it will tune to several high-order harmonics with one condenser and coil arrangement, the highest harmonic should tune where the condenser capacity is at a minimum.

The action of this harmonic generator depends upon decrement; that is, there must be a falling off of the voltage amplitude of the output power before the next kick is obtained from the fundamental frequency. To determine just what order of decrement exists, work is going forward to see if it can be shown on the cathode-ray oscillograph. Some progress has already been made in that direction and some interesting results should be obtained. There exists even the possibility that an 80-meter crystal-controlled circuit may allow us to operate on 160 meters with this new device.

¹ Reinartz, "How Much C?", QST, March, 1937.

Improving DX

(Continued from page 29)

is a well-thought-out one and at the present writing is being voted upon by the member-societies of the Union. It provides, among other things, that all the member-societies agree to the following subdivision of the 7-Mc. band:

7000-7200 kc.—C.w. or 'phone. On every continent, to be used for all communications within the interior of that continent. To be the *only* frequencies in this band used by W/VE amateurs.

7200-7250 kc.—C.w. only. To be used by the amateurs of all continents except Europe and North America, when they desire to work with European and North American amateurs.

7250-7300 kc.—C.w. only. To be used by the amateurs of Europe when they desire to work with the amateurs of other continents.

How would you like it? Think it over. Would it not facilitate your DX work? In return for these benefits, would you be willing to give up your rights to work in the frequencies not therein specified as available for North American amateurs? Both the Editor and the Communications Manager invite reactions.

GAMMATRON!

\$24⁵⁰

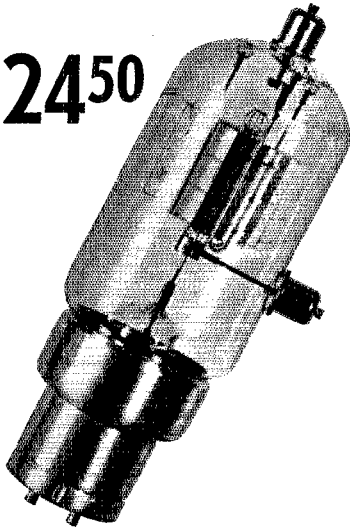

SCORES AGAIN!

3 NEW TUBES

354-D Amplification Factor 22

354-E Amplification Factor 35

354-F Amplification Factor 50

SEND for operating data and curves on these new Gammatrons. All types are 150 watts **RATED** plate dissipation.

AT YOUR DEALER



THE NEW 1938 SUPERSKYRIDER

Just look at these features. Range from 5-550 meters! Variable selectivity control! 1000° of band spread on 20 meters alone! Net price complete, less speaker and crystal, **\$99.00**; extra for 12" pm speaker in cabinet, **\$12.00**; extra for crystal, **\$12.00**.

Immediate Shipment

TIME PAYMENTS ON ALL HALLICRAFTERS SETS

WARD LEONARD — New! Antenna DPDT Changeover Relay, Mycalex insulation, 110 V.A.C. Field **\$5.88**

GENUINE TOBE — 2 Mfd. 2000 V. oil filled filter condensers with standoff insulators **\$2.45**

JOHNSON "Q" ANTENNAS FOR BETTER DX

5Q. Five meter antenna system **\$3.83**
10Q. Ten meter antenna system **3.67**
20Q. Twenty meter antenna system **5.82**

SPECIAL JOHNSON TRANSMITTING CONDENSERS

Type 50 CD 110 split stator 50 mmfd. per section, .350", 11,000 V. spacing *Net \$8.00*
Type 100 CD 110 same as above but 100 mmfd. per section, .350", 13,000 V. spacing *Net \$11.35*
Type 50 CD 130 split stator 50 mmfd. per section, .300", 13,000 V. spacing *Net \$9.14*

Special Heavy Duty Black Crackle Finished Chassis
10" x 17" x 3", \$.98; 10" x 12" x 3", \$.88; 7" x 17" x 2 1/4", \$.82
Other Sizes of Chassis and Cabinets in Stock

KENYON SPECIALS

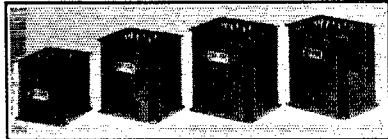

POWER TRANSFORMERS AND CHOKES AT UNHEARD OF PRICES !!! ALL CASED

POWER TRANSFORMERS

D200. 750-1000 V. each side at 300 mls. *Net \$5.25*
D201. 1000-1250-1500 V. each side at 300 mls. " **6.80**
D202. 1500-2000-2500 V. each side at 300 mls. " **11.00**
D203. 1000-1250-1500 V. each side at 500 mls. " **11.00**

SMOOTHING CHOKES

D100. 20 Henries — 200 mls. 2500 V. insulation. *Net \$1.50*
D102. 20 Henries — 300 mls. 2500 V. insulation. " **2.90**
D104. 20 Henries — 400 mls. 5000 V. insulation. " **3.50**
D106. 20 Henries — 500 mls. 6000 V. insulation. " **5.00**

SWINGING CHOKES

D101. 5-25 Henries — 200 mls. 2500 V. insulation. *Net \$1.50*
D103. 5-25 Henries — 300 mls. 2500 V. insulation. " **2.90**
D105. 5-25 Henries — 400 mls. 5000 V. insulation. " **3.50**
D107. 5-25 Henries — 500 mls. 6000 V. insulation. " **5.00**

Heavy Duty 2 1/2 V. 12 amp. 866 fil. trans., 7500 V. insulation, Special. **\$1.18**

Triplet 0-1 mil. D.C. 2" Bakelite case meters **\$3.75**
Triplet R.F. Thermo couple ammeters. 0-2 1/4 amps. or 0-5 amps., 3" Bakelite case. **\$6.53**
All Other Triplet Meters in Stock at Regular Prices

W3AHR

MAIL ORDERS PROMPTLY FILLED

W3BMS

CONSOLIDATED RADIO CORP., 612 Arch St., Philadelphia, Pa.

SOLD BY ASTATIC JOBBERS

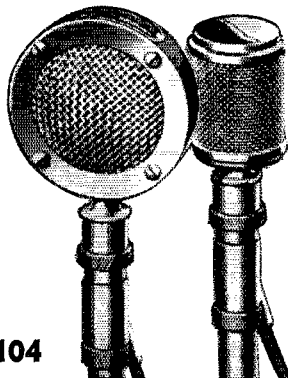

D-104

K-2

A crystal microphone designed for voice transmission and general purpose P.A. installations. Output level -54 DB (conservatively rated). Equipped with interchangeable plug and socket and cable protector. List price..... **\$22.50**

Wide range, non-directional crystal microphone. Interior assembly two dual diaphragm high fidelity units. Equipped also with interchangeable plug and socket and cable protector. New low list price..... **\$27.50**

Licensed under Brush Development Co. Patents

ASTATIC MICROPHONE LABORATORY, INC.
DEPT. Q, YOUNGSTOWN, OHIO, U. S. A.
Pioneer Manufacturers of Quality Crystal Devices

RADIO

ENGINEERING, broadcasting, aviation and police radio, servicing, marine radio telegraphy and telephony, Morse telegraphy and railway accounting taught thoroughly. Engineering course of nine months duration equivalent to three years of college radio work. School established 1874. All expenses low. Catalog free. **DODGE'S INSTITUTE**, Day Street, Valparaiso, Indiana

Unconditionally Guaranteed	PR CRYSTALS	Powerful Reliable
X cut 7000 KC ± 5 KC .. \$1.85	3500 or 1750 .. \$1.65	
Low Drift ± 5KC 40-80-160 .. 2.20		
PETERSEN RADIO CO. COUNCIL BLUFFS, IOWA Formerly Omaha Crystal Labs.		

PROGRESSIVE III

built with



Stream-Line TRANSFORMERS AND CHOKES

gives you highest performance at lowest cost.

Send for FREE Bulletin 44

GENERAL TRANSFORMER CORP.
518 S. Throop St., Chicago

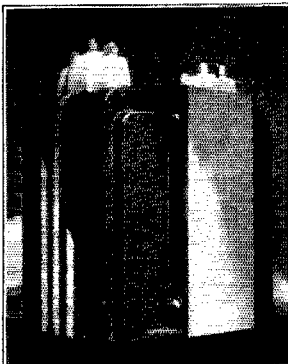

How Would You Do It?

(Continued from page 26)

I—panel for switches controlling 110 v. a.c. power.

J—key.

K—tools, QSL's, neon bulb, plug-in coils, etc.

The shelf at L is mainly a support for the bottom of the structure. It can be used for the speech amplifier and its power unit, and also to accommodate magazines, books and the miscellaneous boxes of screws which, I believe, is standard equipment in every amateur station.

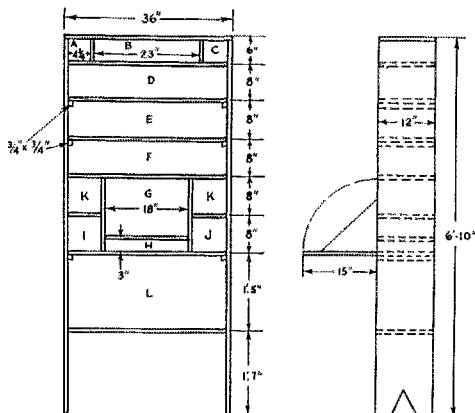

FIG. 3

The space H may be made as a sort of pedestal setting inside the space for the receiver, and the receiver rests upon it. The writing desk is hinged at the bottom and folds up to hide the receiver, etc.

Panels may be used on the shelves that slide out, if so desired. The top and bottom shelves are put in permanently while the ones in between slide out in case repairs to the apparatus become necessary.

I think this rack would be inexpensive as the whole thing is made of 3/4 inch by 12 inch lumber and enough lumber can be purchased for about four dollars.

Honorable mention, for designs which were still on the list at the final judging, goes to the following:

W1EZV, HZK, IMV, JJZ, 2FQK, JSL, 3AYS, GBC, GJT, 4BDE, 6DBF, 9GBM, 80MM, 9FKO, VE4MU, 4QP, J. L. Pratt, Roland Abell, E. A. Krampert, H. R. Wahlin, Keith Henderson, Chas. Zrinsky and N. F. Van Gelder.

Here are the rules governing this contest series:

1. Solutions must be mailed to reach West Hartford before the 20th of the publication month of the issue in which the problem has appeared. (For instance, solutions of problem given in the March issue must arrive at QST before March 20th.) They must be addressed to the Problem Contest Editor, QST, West Hartford, Conn.

2. Manuscripts must not be longer than 1000 words, written in ink or typewritten, with double

(Continued on page 30)

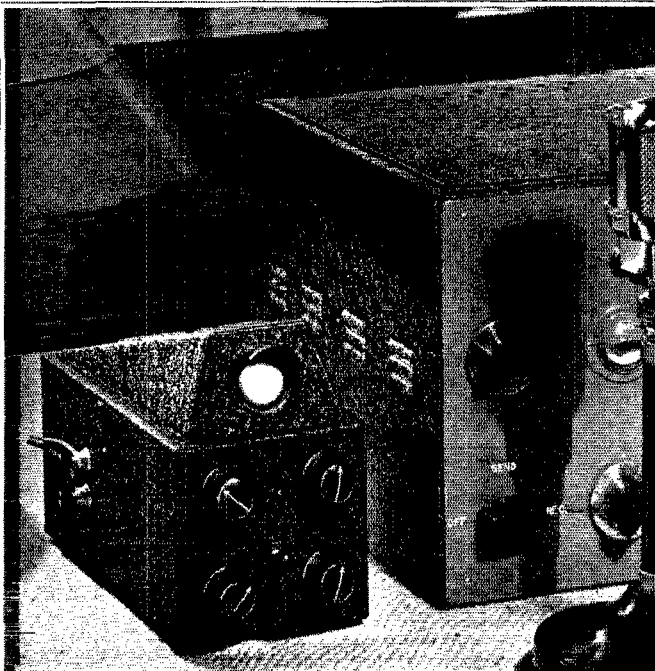

A MINIATURE OSCILLOSCOPE AT A LOW PRICE

The Type CRM Oscilloscope employs the little RCA-913 tube having a one-inch screen. In spite of its small size, this new equipment is thoroughly practical and is quite satisfactory for routine measurements in the amateur station. The circuit includes a power supply with controls for brilliancy and focus, a potentiometer for controlling the amplitude of the horizontal deflection, and a built-in 60-cycle sweep. This latter is particularly convenient as it permits checking transmitter operation with no connection other than a pick-up coil.

NET PRICE \$11.10
Without Tubes

NATIONAL COMPANY, INC.
MALDEN, MASS.

WE OFFER —

SPECIALIZED PERSONAL SERVICE of genuine value that is not available from other jobbers.

TIME SALES of all receivers and transmitters with terms arranged to suit you and 6% finance charge. We finance our own paper. **TRADE IN** your equipment for the down payment.

Complete stock of all amateur apparatus at net prices.

TRADE IN YOUR RECEIVER

All receivers shipped on ten day trial. You need send but \$5.00 with order, balance C.O.D. These receivers in stock:

RME-69s Complete	\$151.20
The new 1937 Breting 14s	108.00
The new Patterson FR-15	109.50
The new RCA ACR-155	74.50
RCA AGR-175s	119.50
The new 1937 Super Pro	238.14
The new Hallicrafters 1938 S16 Super Skyrider	99.00
The new Hallicrafters Sky Challenger S-15	69.50
Hallicrafters Sky Buddys	29.50
Hallicrafters Sky Chiefs	44.50
Hallicrafters Ultra Skyriders S-10	99.50

TRADE IN YOUR TRANSMITTER

All Harvey, RCA, RME, Temco, All Star transmitters at net prices. Sold on terms to suit you with two years to pay and 6% finance charges.

HENRY RADIO SHOP

211 North Main Street

BUTLER, MISSOURI



Some Value!

Genuine oil-impregnated oil-filled high-voltage condensers in round cans.

Hermetically sealed. High-tension pillar insulator terminals. Positively seepage proof.

1000, 1500 and 2000 v. 1 to 4 mfd. Mass produced for lowest prices and genuine quality.

DATA . . .

Latest catalog just off the press. More pages. More items. More choice. Ask your local supplier or write us for copy.



Where to buy it

A directory of suppliers who carry in stock the products of these dependable manufacturers.



ALBANY, N. Y. Uncle Dave's Radio Shack 356 Broadway

BALTIMORE, MD. Radio Electric Service Company 3 North Howard St.

BOSTON, MASS. Radio Shack 46 Brattle Street

HARTFORD, CONN. Radio Inspection Service Co. 227 Asylum Street

NEWARK, N. J. Wholesale Radio Service Co., Inc. 219 Central Ave.

NEW YORK, N. Y. Gross Radio, Inc. 51 Vesey St.

NEW YORK, N. Y. Harrison Radio Co. 12 West Broadway

NEW YORK, N. Y. Wholesale Radio Service Co., Inc. 100 Sixth Ave.

NEW YORK, N. Y. Terminal Radio Corp. 80 Cortlandt Street

POTTSVILLE, PENN. E. Norwegian & George Sts. Sylvester Radio & Supply Co., Inc.

READING, PENN. George D. Barbey Company 404 Walnut St.

READING, PENN. Sylvester Radio & Supply Co., Inc. 104 North Ninth Street

SPRINGFIELD, MASS. I. F. Cushing 349 Worthington St.

WASHINGTON, D. C. Sun Radio & Service Supply Co. 938 F Street, N. W.



ALBANY, N. Y. Uncle Dave's Radio Shack 356 Broadway

BALTIMORE, MD. Radio Electric Service Company 3 North Howard St.

BOSTON, MASS. H. Jappe Company 46 Cornhill

BOSTON, MASS. Radio Shack 46 Brattle Street

BURLINGTON, VERMONT Vermont Hardware Co., Inc.

CAMDEN, NEW JERSEY Radio Electric Service Company 811 Federal Street

GREENWICH, CONN. Mead Stationery Company 252 Greenwich Ave.

HARTFORD, CONN. Radio Inspection Service Co. 227 Asylum Street

MONTREAL, CANADA 285 Craig Street, West Canadian Electrical Supply Co., Ltd.

NEWARK, N. J. Wholesale Radio Service Co. 219 Central Avenue

NEW YORK, N. Y. Bruno-New York, Inc. 460 W. 34th St.

NEW YORK, N. Y. Sanford Samuel Corp. 136 Liberty St.

NEW YORK, N. Y. Wholesale Radio Service Co. 100 Sixth Avenue

NEW YORK, N. Y. Harrison Radio Company 12 West Broadway

NEW YORK, N. Y. Grand Central Radio, Inc. 124 E. 44th Street

PHILADELPHIA, PENN. Eugene G. Wile 10 S. 10th Street

PHILADELPHIA, PENN. Raymond Rosen & Company 117 North 7th St.

PHILADELPHIA, PENN. M & H Sporting Goods Company 512 Market Street

PHILADELPHIA, PENN. Radio Electric Service Company 3145 N. Broad Street

PHILADELPHIA, PENN. N.E. Corner 7th & Arch Streets Radio Electric Service Company

POTTSVILLE, PENN. E. Norwegian & George Sts. Sylvester Radio & Supply Co., Inc.

READING, PENN. Bright & Company 8th & Elm Streets

READING, PENN. Sylvester Radio & Supply Co., Inc. 104 North Ninth Street

Where to buy it

A directory of suppliers who carry in stock the products of these dependable manufacturers.

SPRINGFIELD, MASS. 349 Worthington Street
T. F. Cushing

SPRINGFIELD, MASS. 1540 Main Street
S. S. Kresse Radio Department

WASHINGTON, D. C. 938 F Street, N. W.
Sun Radio & Service Supply Co.

RME
RECEIVERS -- PRE SELECTORS
AMATEUR RADIO EQUIPMENT
RADIO MFG. ENGINEERS, Inc.
PEORIA ILLINOIS

ALBANY, NEW YORK 356 Broadway
Uncle Dave's Radio Shack

BINGHAMTON, NEW YORK 25-27 Sturges Street
Radio Testing Station

BUFFALO, NEW YORK 216 E. Genessee Street
Dymac Radio

HARTFORD, CONNECTICUT 210 Chapel Street
Stern Wholesale Parts Company

NEW YORK, N. Y. 12 West Broadway
Harrison Radio Company

NEW YORK, N. Y. 80 Cortlandt Street
Terminal Radio Corp.

ROCHESTER, NEW YORK 244 Clinton Ave., N.
Radio Service Shop

WASHINGTON, D. C. 1837 Vernon St., N.W.
Upshur Radio Company

RAYTHEON
TRADE MARK
AMATEUR TUBES

ALBANY, NEW YORK 356 Broadway
Uncle Dave's Radio Shack

BOSTON, MASS. The Radio Shack 46 Brattle Street

BOSTON, MASS. Selden Radio Company 28 Brattle Street

BUFFALO, NEW YORK 326 Elm Street
Radio Equipment Corp.

CONCORD, NEW HAMPSHIRE 80 N. State Street
Carl B. Evans

NEWARK, NEW JERSEY 219 Central Street
Wholesale Radio Service Co.

NEW YORK, N. Y. 12 West Broadway
Harrison Radio Company

NEW YORK, N. Y. 100 Sixth Avenue
Wholesale Radio Service Co.

WASHINGTON, D. C. 938 F Street, N. W.
Sun Radio & Service Supply Co.

TRIPLER
INSTRUMENTS

ALBANY, N. Y. 356 Broadway
Uncle Dave's Radio Shack

BOSTON, MASS. Radio Shack 46 Brattle Street

BOSTON, MASS. Selden Radio Company 28 Brattle St.

MONTREAL, CANADA 285 Craig Street, West
Canadian Electrical Supply Co., Ltd.

NEWARK, N. J. 219 Central Ave.
Wholesale Radio Service Company

NEW YORK, N. Y. 100 Sixth Avenue
Wholesale Radio Service Company

POTTSVILLE, PENN. E. Norwegian & George Sts.
Sylvester Radio & Supply Co., Inc.

READING, PENN. 404 Walnut Street
George D. Barbey Company

READING, PENN. 104 North Ninth St.
Sylvester Radio & Supply Co., Inc.

WASHINGTON, D. C. 938 F Street, N. W.
Sun Radio & Service Supply Co.

4 BAND Type HFM

Portable Crystal Control

7000-60,000 Kc.
PHONE—CW—MCW

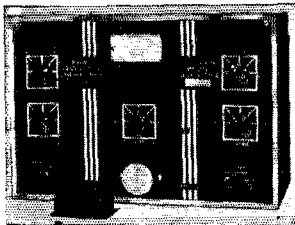

- Single 40 Meter Crystal for All Bands
 - A.C. or Battery Operation
 - Complete With Coils for 5-10-20 and 40 Meters
- H-F-M
TRANSMITTER
\$48.00

"Type TR-6A6"

- Non-radiating Rec'vr
 - 7 Tubes — Jensen Dynamic Speaker
 - 6E6 Unity Coupled Oscillator
 - 10 Watt Carrier
 - 100% Modulation
 - Duplex Operation — PHONE ● MCW
- TRANSMITTER—RECEIVER
\$39.75

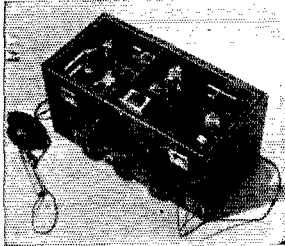

RADIO TRANSCEIVER LABORATORIES
8627 — 115 Street, Richmond Hill, New York

Improves Your 'Fist'

Cuts Effort in Half
Insist on The Genuine Martin
VIBROPLEX
SEMI-AUTOMATIC KEY

Simply press lever—
machine does the rest

JUNIOR
ONLY
\$12.50

Small and more compact. Large contact points. Black japanned base. A low priced key with world famous Vibroplex Quality. Other models, \$17 and \$19.

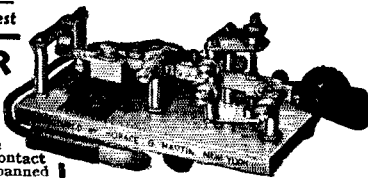

Vibroplex's machine speed, superior signal and effortless operation assures the user the fastest, best and easiest way to send. Experienced operators know this — that's why over 100,000 of them use only the Vibroplex key.

Faster than the fastest hand sender — less than half the effort. Easy to learn. Easy to use. Easy to own. Order to-day! Insist on the Genuine Martin Vibroplex key. Accept no substitute. Liberal allowance on old Vibroplex. Money order or registered mail. Write for FREE illustrated catalog just off the press.

FREE
CATALOG



THE VIBROPLEX CO. Inc.

832 Broadway

New York, N. Y.

RADIO COURSES

RADIO OPERATING; Prepare for Gov't License Exam. ●
RADIO SERVICING; Including Short Wave ● AMATEUR
CODE ● ELECTRONICS ● TELEVISION ●

Day and Evening classes—Booklet upon request

NEW YORK YMCA SCHOOLS

4 West 63rd Street, New York City

(Continued from page 88)

spacing, on one side of the sheet. Diagrams and sketches may be in pencil, but must be neat and legible.

3. All solutions submitted become the property of *QST*, available for publication in the magazine.

4. The editors of *QST* will serve as judges. Their decision will be final.

Prizes of \$5 worth of A.R.R.L. station supplies or publications will be given to the author of the solution considered best each month, \$2.50 worth of supplies to the author of the solution adjudged second best. The winners have the privilege, of course, of stating the supplies preferred.

—D. H. M.

Our hero, who is getting along so well these days because of the help received from this series of problem contests, is fast running out of problems. We can see that our readers will have to step forward with some of their own troubles if this department is to be kept going. The quantity of solutions received is excellent. We need some suggestions for problems—we need 'em badly. Can it be that we amateurs have the ham game licked?—EDITOR.

New Beam Power Tubes

(Continued from page 18)

The RK-48 is the beam counterpart of the RK-28. The ratings of the two tubes are approximately the same, although the RK-48 will give somewhat higher plate efficiency. Tentative ratings and characteristics are:

Filament voltage.....	10 volts
Filament current.....	5 amp.
Plate voltage, max.....	2000 volts
Screen voltage, max.....	400 volts
Plate dissipation, max.....	100 watts
Screen dissipation, max.....	35 watts
D.c. grid current, max.....	25 ma.
R.f. grid current, max.....	8 amp.

As a Class-C amplifier, the bias should be -100 volts at the maximum plate and screen voltages. In operation, with the plate load adjusted for maximum efficiency, the following data are typical:

Plate voltage.....	2000 volts
Screen voltage.....	400 volts
Grid voltage.....	-100 volts
Plate current.....	180 ma.
Screen current.....	75 ma.
Plate dissipation.....	93 watts
Driving power.....	1.95 watts
Grid current.....	10 ma.
Power output.....	225 watts

The RK-48 and RK-28 are identical in appearance and basing. As with the RK-47, the beam-forming plates are connected to the suppressor pin, and this connection should be grounded.

Incidentally, there is no benefit to be gained by operating either of the new beam tubes with positive potential on the beam-forming plates. Doing so does not increase the output, and probably has no effect except to use up some electron emission which might otherwise be usefully employed by the plate.

—G. G.

HAM-ADS

(1) Advertising shall pertain to radio and shall be of nature of interest to radio amateurs or experimenters in their pursuit of the art.

(2) No display of any character will be accepted, nor can any special typographical arrangement, such as all or part capital letters be used which would tend to make one advertisement stand out from the others.

(3) The Ham-Ad rate is 15¢ per word, except as noted in paragraph (6) below.

(4) Remittance in full must accompany copy. No cash or contract discount or agency commission will be allowed.

(5) Closing date for Ham-Ads is the 25th of the second month preceding publication date.

(6) A special rate of 7¢ per word will apply to advertising which, in our judgment, is obviously non-commercial in nature and is placed and signed by a member of the American Radio Relay League. Thus, advertising of bona fide surplus equipment owned, used and for sale by an individual or apparatus offered for exchange or advertising inquiring for special equipment, if by a member of the American Radio Relay League, is at the 7¢ rate. An attempt to deal in apparatus in quantity for profit, even if by an individual, is commercial and takes the 15¢ rate. Provisions of paragraphs (1), (2), (4) and (5) apply to all advertising in this column regardless of which rate may apply.

Having made no investigation of the advertisers in the classified columns, the publishers of *QST* are unable to vouch for their integrity or for the grade or character of the products advertised.

QUARTZ—direct importers from Brazil of best quality pure quartz suitable for making piezo-electric crystals. Diamond Drill Carbon Co., 719 World Bldg., New York City.

RADIO engineering, broadcasting, aviation and police radio, servicing, marine and Morse telegraphy taught thoroughly. All expenses low. Catalog free. Dodge's Institute, Byrd St., Valparaiso, Ind.

NATIONAL—Hammarlund, RCA-RME used sets, 60% off list. W3DQ, 405 Delaware Ave., Wilmington, Del.

QSL's, W2BN, Helmetta, N. J.

CALLBOOKS—new DX calls, new prefixes, thousands of new W and VE calls, in the Summer, 1937 Radio Amateur Call Book. Sent postpaid \$1.25, or a whole year (four issues) for \$4. (In foreign countries \$1.35 and \$4.35.) Your call and QRA printed in large type \$1 per year. Radio Amateur Call Book, 610 S Dearborn, Chicago.

TELEGRAPH speed keys in kit form, only \$2.89. A post card brings full information, Electric Specialty Mfg. Co., PO Box 645 Cedar Rapids, Iowa.

QSL's, all colors, cartoons, snappy service. Write for free samples today. WIBEF, 16 Stockbridge Ave., Lowell, Mass.

QSL's—Special introductory offer extended. Radio Headquarters, Ft. Wayne, Ind.

WEAK headphones rejuvenated scientifically. Makes them like new. Any except crystals, 70¢ per pair in U.S.A. (no stamps). Postpaid, insured. W2AMP, Box 731, Newark, N. J.

WESTERN Electric amplifiers and equipment; 8A, \$25; 8B, \$35; 17B, \$35; volume indicators, \$20; 10A, \$35; rectifier panels 1B, \$59; 6000A, \$75; 514A meter panels, \$17.50; 57AF condensers 2 mfd., 59¢; 95D 1 mfd., 75¢. Assorted transformers, chokes, resistances, condensers, and Weston meters. List available. Hass Radio, 427 Fulton St., Brooklyn, N. Y.

COMPLETE training for all amateur and professional radio licensee. New York Wireless School, 1123 Broadway, N. Y.

SW-3 in perfect condition, \$25. 2.5 volt A.C. tubes included. 160 m, 80 m, 40m bandsread and 20m full coverage coils. WSOTD.

SELL or swap Candler advanced code course as part payment for battery SW3, W2JRS.

QSL's—2 color—\$1. hundred. Samples. Stamp. W8NOS.

WANTED—used Collins 45-A, Gross CB-100. W9SEFX, Manly, Iowa

QSL's. Samples. Stamp. Printer. Corwith, Iowa.

TRANSMITTING tubes repaired, exchanged. Buy or sell all types. W2AWZ, Dobbs Ferry, N. Y.

QSL's. Cartoons. Free samples. Theodore Porcher, 7708 Navahoe St., Philadelphia, Penn.

QSL's, SWL's. Big variety samples. (Stamp) W8DED, Holland, Mich.

SACRIFICE: 2-5 meter xmitters complete with rack, 1—SW receiver, monitor and SW equipment. W9MGM, 5038 Sunnyside Ave., Chicago, Ill.

QSL's, SWL's, 100, 3 color—75¢. Lapco, 344 W. 39th, Indianapolis, Ind.

SELL—trade Mac Key and 1200 volt supply 40 meter crystal 211's. WIDLZ.

QSL's, SWL, reply getters. Samples (stamps). W8ESN, 1827 Coue, Toledo, Ohio.

WANTED: gasoline motor generator or generator alone, 110 A.C. volts, 200-1000 watts. W3DXV.

SELL—National S.W.5, complete. National AB Velvet power unit. Speaker. Band spread and regular coils. Tubes. \$20. F.O.B. Glendale, Cal. W6MQA.

CHICAGO and vicinity: sell ½ k.w. CW transmitter. Want good 8 MM projector. T. A. Hansen, 8105 Osceola Ave., Niles, Ill.

FOR sale: 1000 volt 1 amp. Esco generator 3500 R.P.M. Field separately excited. Best offer. WICKF, Middle Haddam, Conn. BEST offer takes excellent SX9 Super Sky rider. Jesse Jones, 931 National, Vicksburg, Miss.

MUST sell complete 200 watt fone and CW xmitter; de luxe steel enclosed 6 ft. cabinet, 100% Thordarson and Hammarlund equipped. Make offer, W2ISS.

5 meter Hains. Sure fire results for receiving and transmitting. Any power. Using this new type coil to match feed line to antenna. This has been tried against every known system with superior results. Complete with instructions, \$1.50. Bates Lab., N. Harwich, Mass.

JUNKING bargain de luxe; all of 8fsy's 300 watt phone. Highest grade Acme Delta equipment, microphone, meters. Priced to sell. List free. W8PNL, John Stiles, Potsdam, N. Y.

SELL or trade for good camera—Patterson PR16C. W. P. Cecil, Norco, La.

QSL's. 300 one-color cards, \$1. Samples. 2143 Indiana Ave., Columbus, O.

TRANSFORMERS—custom-built. Write for list. July specials—¾ KVA plate transformers—your voltages, \$9; 1 KVA, \$14. Baker Engineering, Ft. Wayne, Ind.

QSL's. Beautiful designs. Free samples. Maleco, 1512 Eastern Parkway, Brooklyn, N. Y.

GENERAL Electric dynamotors 24 volts to 750 200 mills, \$25. Two machines for 1500 volts, \$20 each. 500 watts 500 cycles, \$10; slightly used, \$6. Westinghouse ½/350, \$10. 6-15 volts 500 watts with propeller, \$10. 200 watt 900 cycles, \$15. List. Henry Kienzle, 215 Hart Blvd., Staten Island, N. Y.

FBXA, power supply, coils, speaker, new tubes, factory rebuilt, \$40. H. Button, Aberdeen, S. Dakota.

QSL's printed. Samples. W2AEY.

COLLINS 32B, extras \$100. W2ETD.

TELEPLEXES, vibroplexes bought, sold, traded. Ryan Radio Co., Monroe City, Mo.

SELL: Hallcraftor Skybuddy, \$24. W3FYW, Ardmore, Penn. SW3, power supply, tubes, coil cabinet, 8 sets coils, perfect condition. Make offer. Lorensen, Southern Pines, N. C.

T9 crystals 40 and 80 meters, \$1.60 postpaid. Close frequency supplied. Remember: There was never anything that couldn't be made worse and sold for less—so buy T9 crystals resisting, dependable X cut—worth the difference. T9 ceramic holders, \$1.10 postpaid. C.O.D.'s O.K. Eidson's, Temple, Texas or Hieronymus Radio, 88-84 209 St., Queens Village, N. Y.

CRYSTALS, X cut, 160-80 meters. Exact specified frequency, \$2.50. Within five kilocycles, \$1.50. Stock crystals, close to desired frequency, \$1.25. Three 80 meter, semi-finished blanks, including carborundum, \$1.20. Plugin holders, 85¢. William Threm, W8FN, 4021 Davis Ave., Cheviot, Ohio.

GUARANTEED crystals 75¢ each postpaid, Faberadio, Sandwich, Ill.

PLATE transformers, 2000 C.T. 250 M.A., \$5. Ward Transformer, 27 Houston St., Buffalo, N. Y.

QSL's—Design your own—New process—Better and cheaper. Write for free kit. QSL Company, Box 481, Hartford, Conn.

HEAVY-duty transmitting keys, \$1.60. 3/16" coin silver contacts, black crackle base, nickel plated arm and binding posts, navy type knob. Send stamp for circular. E. Rooske, 2037 Waveland Ave., Chicago, Ill.

BELL 2C amplifier, new tubes, \$20. New A.C. Dayrad all-wave signal generator, \$20. General Radio No. 358 Wavemeter, \$5. Will trade a lot of BC sets and misc. parts for xmitting equip. Send for complete list. Blum, 895 Ebner St., Columbus, Ohio.

RECEIVER: RCA ACR-136—bargain—slightly used, tuning eye. First \$40 or what? Scott, 324 W. 8th St., Covington, Ky.

RECEIVER headquarters. W8ANT.

RME69's and **DB20's** in stock. W8ANT.

HALLCRAFT 1938 Super Skyriders in stock. W8ANT.

HARVEY transmitters. W8ANT.

UTC specials—bargains. W8ANT.

ALL lines of new and used equipment at lowest wholesale prices. Write to Southern Ohio's only amateur owned amateur business. Jos. N. Davies, W8ANT, 2767 N. Bend Rd., Sta. A, Cincinnati, Ohio.

TRANSMITTER: Collins 150BA-100W-47 oscillator-2-46's, 1-203A-crystals; 7.1 and 3.9-coils 20, 80-PI network modulators: 2-203A-CLB—also Collins 7CA speech amplifier: 57-56-56-2: 2A3 P.P.—on five foot rack—complete with 110V-60 cycles supply, nine instruments all tubes Bruno SK4H microphone. Excellent condition. For best cash offer. W3FTW, 4505 Ridge St., Chevy Chase, Md.

RECEIVER—RCA Communications Model ACR-136. Like new. Complete. First \$45 takes it. Chester A. Charles, Du Pont Airport, Wilmington, Del.

NEW Cosman 4 factory receiver, metal tubes 15-550 band switch, built in power pack and dynamic speaker. First \$18. C. Kuhn, Airport, Anderson, S. C.

SELL: A-1 National FBXA (20-40-80-160) coils and power: Peak Preselector; 5 & 10 meter superhetrodyne; Tube all-wave receiver. Best offers take. W3BBV, 859 E. Market, York, Penn.

SELL: Super Skyriders, \$29; ACR-136's, \$39; Silver 5B's, \$34; Scot XV, \$69; other sets. W9ARA, Butler, Mo.

GENUINE EO-1 Cable, by Graham, manufactured by General Cable Corp., sold by W8DT. QSL card for data.

SELL 500 back issues QST. W8DT.

QSL'S. Better designs; better stock; better workmanship. Free samples to hams only. W2FJE, 143 DeKalb Ave., Brooklyn, N. Y.

BEST offer takes 2 volt D.C. SW3, 5 sets coils, tubes. W3FVK. TRANSMITTERS constructed. Complete or units. Your parts or new. State requirements fully. Superior workmanship. Howard Radio, 5514 Lake St., Chicago.

TRANSMITTING tubes, repaired, exchanged, buy or sell all types. W2AWZ, Dobbs Ferry, N. Y.

RCA course, \$6. Radio-Doctor's Course, \$3. Preston Analyser, \$6. Law course, for good receiver. Want Rider's Manuals. Muggins, Gid, Ark.

QSL'S, summer special. W8JDW, Lima, Ohio.

YOU ARE INVITED TO INVESTIGATE
THE MANY ADVANTAGES OFFERED BY

EASTERN RADIO INSTITUTE

899 BOYLSTON STREET, BOSTON, MASS.

PRECISION CRYSTALS



Crystal Holder

Highest quality crystals, one inch square, carefully ground for frequency stability and maximum output. Be sure of your transmitter frequency — use PRECISION CRYSTALS.

Low frequency drift crystals (Type LTC) supplied within 0.1% of your specified frequency and calibrated to within 0.03% are priced as follows: 1750 and 3500kc. bands—\$3.50 each. 7000 kc. band \$4.00 each. Holder \$1.00.

(Holder as illustrated to fit G.R. jacks or round holder to plug into a tube socket can be furnished. G.R. jacks to plug illustrated holder into — \$1.15 pair.)

'X' cut PRECISION Crystals carefully ground for maximum power supplied within 0.1% of your specified frequency and calibrated to within 0.03% are priced as follows: 1750, 3500 and 7000 kc. bands — \$3.00 each. Add \$1.00 if holder is desired.

'AT' cut crystals for commercial use quoted on at your request. When ordering our product you are assured of the finest obtainable. Now in our seventh year of business.

PRECISION PIEZO SERVICE

427 Asia Street Baton Rouge, La.

110 VOLTS AC
Anytime! Anywhere! With
KATOLIGHT PLANTS

850 Watts AC and 6 Volts DC . . \$ 89.50
550 Watts AC and 6 Volts DC . . 220.00
1900 Watts AC and 19-32 Volts DC . 294.00
Portable-Self-Cranking
Ask for Special Discount to Amateurs
800 watts 110 v. A.C. Generator only \$12.50
6, 12, 32 and 110 volt Rotary Converters.
AC/DC and DC Generators, Etc., etc.

Write for Details
KATO ENGINEERING COMPANY
Mankato, Minnesota, U.S.A.

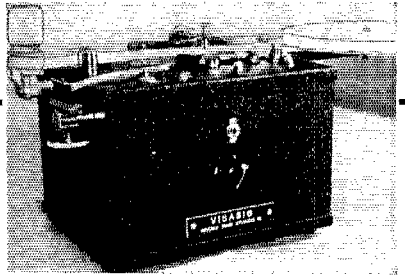
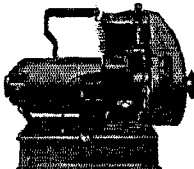

VISASIG Full Automatic Siphon Tape Recorder

Records code signals from receiver up to and over 100 wpm. VISASIG with electrically driven tape puller, constant level ink feed and 1500 ft. tape capacity complete in one unit. . . . \$69.00

Price F.O.B. New York City

UNIVERSAL SIGNAL APPLIANCES

Dept. A, 64 West 22nd Street

New York City

Visasig Blueprints \$1.00

HOW TO LEARN CODE

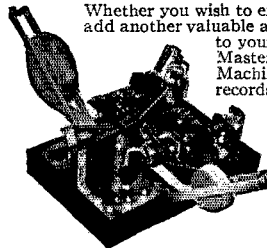

Whether you wish to enter radio as a career or merely add another valuable and fascinating accomplishment to your achievements, the All Electric Master Teleplex Code Teaching Machine will show you how. Teleplex records your sending in visible dots and dashes on a specially prepared waxed paper tape and then sends back to you at any speed you desire. It does not merely show your code. It is code. No experience needed. Beginners, amateurs, experienced ops. get ahead faster this better way. We furnish you complete

course, including practice messages, the All Electric Master Teleplex, plus a personal service on a MONEY BACK GUARANTEE. Low cost. Easy terms. Without obligation write for booklet "Q7."

THE "HAM" SPECIAL

Standard Teleplex—a highly efficient code teacher using heavy specially prepared waxed paper tape, having two rows of perforations. Write for Free folder "Q.T.7."

We are the originators of this type instrument

TELEPLEX CO. 72-76 CORTLANDT STREET
NEW YORK, N. Y.

"Put Your Signal Where You Want It When
You Want It There"

MIMS SIGNAL SQUIRTER

ROTARY BEAM ANTENNAS

20 and 14 Meters Only

Listen for—or see them at W4DLH, W2JKQ, Ve3LL, W4EED, W9DN, W6MKD, W6FJL, W9RGH, W9BHT, W3FAM, W5ACE, W4OC, W9ZDO and W5BDB. Send 5c for information.

MIMS RADIO COMPANY

M. P. MIMS—W5BDB, P. O. Box 504, Texarkana, Ark.

Your Nearest Dealer Is Your Best Friend

Your nearest dealer is entitled to your patronage. You can trust him. He is equipped with a knowledge and understanding of amateur radio. He is your logical and safe source of advice and counsel on what equipment you should buy. His stock is complete. He can supply your needs without delay. His prices are fair and consistent with the high quality of the goods he carries. He is responsible to you and interested in you.

Patronize the dealer nearest you—You can have confidence in him

<p>ALLENTOWN, PENNSYLVANIA Radio Electric Service Co. 1024 Hamilton Street Complete stocks transmitting equipment</p>	<p>NEW YORK, N. Y. Harrison Radio Company 12 West Broadway "The Friendly Ham Supply House"</p>
<p>ATLANTA, GEORGIA Wholesale Radio Service Company, Inc. 430 West Peachtree Street, N. W. "The World's Largest Radio Supply House"</p>	<p>PHILADELPHIA, PENNSYLVANIA Radio Electric Service Co., Inc. N. E. Cor. Seventh & Arch Sts. All nationally-advertised lines in stock</p>
<p>BALTIMORE, MARYLAND Radio Electric Service Co. 3 N. Howard St. Everything for the amateur</p>	<p>PHILADELPHIA, PENNSYLVANIA Eugene G. Wile 10 S. Tenth Street Complete Stock of Quality Merchandise</p>
<p>BRONX, NEW YORK Wholesale Radio Service Company, Inc. 542 East Fordham Road "The World's Largest Radio Supply House"</p>	<p>PROVIDENCE, RHODE ISLAND W. H. Edwards Co. 32 Broadway National, Taylor Tubes, Hellicrafters. Complete amateur supply house</p>
<p>BUFFALO, NEW YORK Radio Equipment Corp. 326 Elm Street W80BK — Ham, service and sound equipment — W80LB</p>	<p>PROVIDENCE, RHODE ISLAND Kraus & Company 89 Broadway Everything for the amateur and serviceman</p>
<p>BUFFALO, NEW YORK Dymac Radio 216 E. Genesee Street Complete Line Ham and BCL Equipment Cl. 2080</p>	<p>RICHMOND, VIRGINIA The Arnold Company 527 W. Broad Street W3EHL—"The Virginia Ham Headquarters"—W3FBL</p>
<p>JAMAICA, L. I. Wholesale Radio Service Company, Inc. 90-08 166th Street (Merrick Road) "The World's Largest Radio Supply House"</p>	<p>ROCHESTER, NEW YORK Radio Service Shop 244 Clinton Avenue, North Complete stock amateur-BCL parts. Standard discounts. W8NUC</p>
<p>MONTREAL, CANADA Canadian Elec. Supply Co., Ltd. 285 Craig St., W. Quality parts and equipment for discriminating buyers</p>	<p>SYRACUSE, NEW YORK Roy C. Stage, W8IGF Complete stock of standard Ham & BCL parts Standard Discounts. Free technical service</p>
<p>NEWARK, N. J. Wholesale Radio Service Company, Inc. 219 Central Avenue "The World's Largest Radio Supply House"</p>	<p>SPRINGFIELD, MASS. S. S. Kresge Company 1540 Main Street Standard discounts, standard lines. Advisory service: W1JQ, W1FOF</p>
<p>NEW YORK, N. Y. Gross Radio, Inc. 51 Vesey Street Fair dealings plus fair prices. Anything in radio</p>	
<p>NEW YORK, N. Y. Wholesale Radio Service Company, Inc. 100 Sixth Avenue "The World's Largest Radio Supply House"</p>	

You Are Protected When You Buy From QST Advertisers

“Advertising for QST is accepted only from firms who, in the publisher’s opinion, are of established integrity and whose products secure the approval of the technical staff of the American Radio Relay League.”

Quoted from QST’s advertising rate card.

Every conceivable need of a radio amateur can be supplied by the advertisers in QST. And you will know the product has the approval of the League’s technical staff.

For Your Convenience QST'S INDEX TO ADVERTISERS IN THIS ISSUE

Aerovox Corporation	87
Birnback Radio Industries, Inc.	82
Astatic Microphone Laboratory	86
Bellefonte Radio Eng. & Mfg. Co., Inc.	75
Birnback Radio Company	78
Biley Electric Company	79
Burgess Battery Company	59
Candler System Company	54
Capitol Radio Engineering Institute	70
Cardwell Mfg. Corp., Allen D.	62
Centralab	51
Code-Craft	52
Cohen's Sons, Ltd., L. S.	85
Collins Radio Company	Cov. 2
Consolidated Radio Corporation	85
Cornell-Dubilier Corporation	70
Delaware Radio Sales Company	71, 81
Delco-Remy Corporation	65
Dodge's Institute	86
Douglas Radio Products	83
Eastern Radio Institute, Inc.	92
Eitel-McCullough, Ltd.	67
General Transformer Corporation	86
Gross Radio, Inc.	66
Gulf Radio School	83
Hallcrafters, Inc., The	1, 2
Hammarlund Manufacturing Company	3
Harvey Radio Company	77
Harvey Radio Laboratories, Inc.	71
Heintz & Kaufman, Ltd.	85
Henry Radio Shop	87
Hipower Crystal Company	80
Instructograph Company	79
International Resistance Company	47
Johnson Company, E. F.	80
Kato Engineering Company	92
Kenyon Transformer Company	81
Leeds	64
Littelfuse Laboratories	79
Mallory & Company, Inc., P. R.	46, 61
McElroy, T. R.	75
McGraw-Hill Book Company	56
Midland Television, Inc.	58
Mims Radio Company	92
National Company	Cov. 3, 45, 75, 79, 87
Newark Electric Company	63
New York Y. M. C. A. Schools	90
Ohmite Manufacturing Company	74
Petersen Radio Company	86
Port Arthur College	75
Precision-Piezo Service	92
RCA Institutes, Inc.	79
RCA Manufacturing Company	Cov. 4, 53
Radio Mfg. Engineers, Inc.	95
Radio Shack	77
Radio Supply Company	81
Radio Transceiver Laboratories	90
Scientific Radio Service	83
Shure Brothers	78
Sickles Company, F. W.	81
Speer Carbon Company	82
Standard Transformer Corporation	74
Sun Radio Company	84
Taylor Tubes, Inc.	57
Teleplex Company	92
Terminal Radio Corporation	76
Thordarson Elec. Mfg. Company	55
Triplett Electrical Instrument Co.	52
United Transformer Company	96
Universal Signal Appliances	92
Utah Radio Products Corporation	60
Vibroplex Company	90
Western Electric Company	50
Wilson, Willard S.	71, 81
Vaxley	46

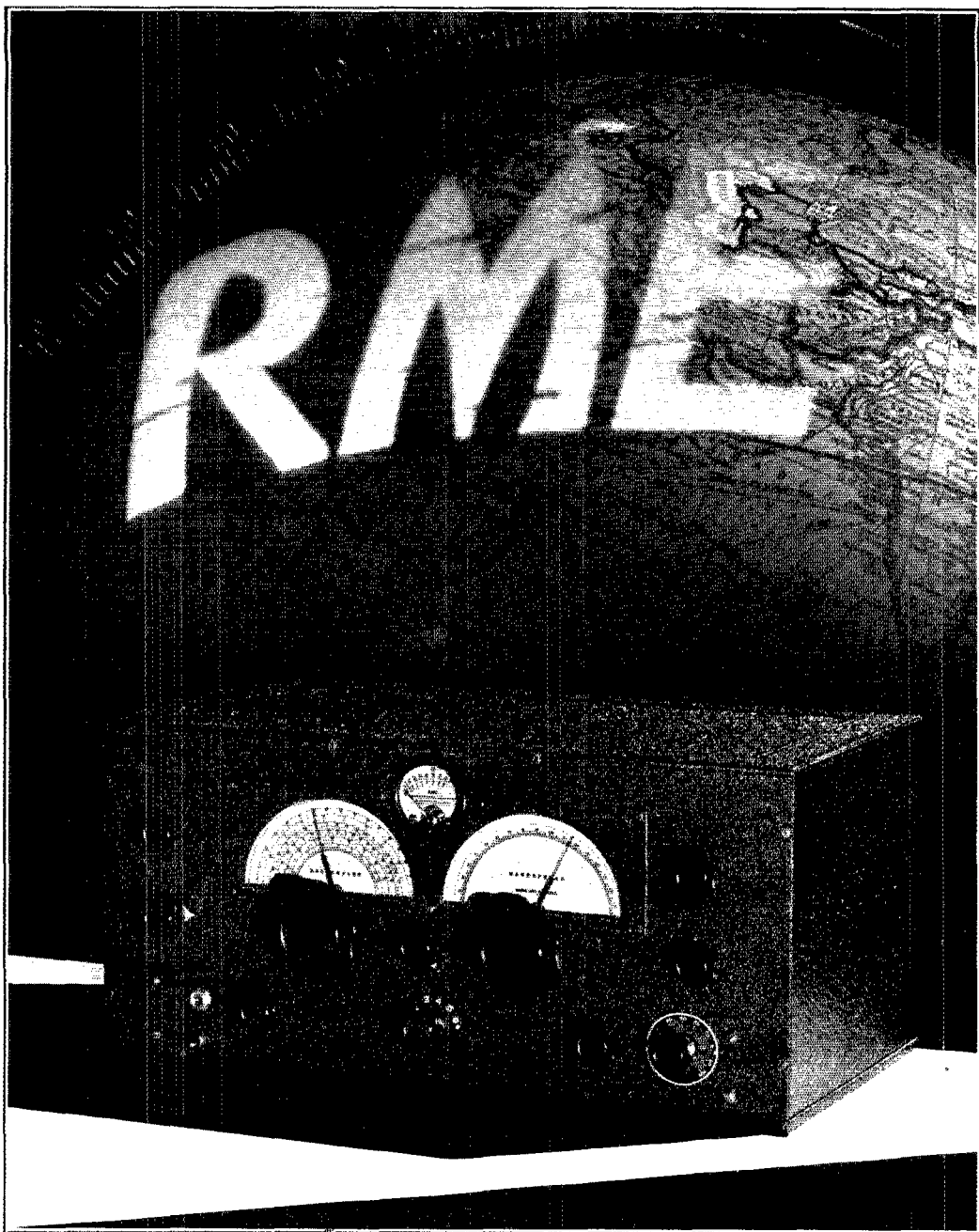

For Consistent World-wide Reception . . .

an **RME - 69**

Literature on Request

RADIO MFG. ENGINEERS • PEORIA ILLINOIS

New UTC Beam Power Amplifiers

The UTC PAK kits are now acknowledged by the field as ideal Universal amplifiers. PAK power amplifier kits are available with outputs of 8, 15, 35, 55, 70, 110 and 250 watts. Stabilized feedback can be used in the PAK-1, PAK-2, PAK-3 and the PA output transformers have special feedback windings for this purpose. There is provision for mixing of two high impedance inputs. An etched panel providing a dual gain, two position mixer with gain links for high or low gain on each position and a VARITONE equalizer control are now standard equipment on these kits.

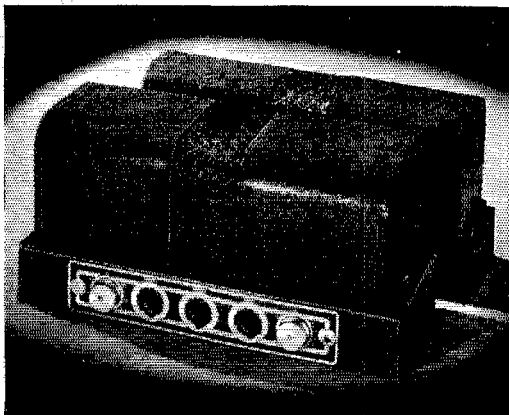

PAK-1M

PAK-1M—Self bias 35 watt output. Audio and power on separate chassis for rack or cabinet mounting. High impedance input 110 to 120 DB gain. Provision for immediate switchover to 95 DB gain on either high impedance input. Output transformer impedances 500, 200, 16, 8, 5, 3, 1.5 ohms. Includes all components and accessories such as resistors, condensers, sockets, calibration plates, etched mixer panel, controls and accessories for a dual gain, two position high impedance mixer, chassis, dust covers with handles, hardware—except tubes—all fully mounted. Net price \$48

PAK-1XM

PAK-1XM—Same as PAK-1M but with VARI-MATCH modulation output transformer. Impedances available are 220, 408, 1180, 2350, 2400, 3000, 4000, 4670, 4750, 5560, 7000, 9150, 9470 ohms. Net price \$48

PAK-2M

PAK-2M—Same chassis layout as PAK-1M but has output of 55 watts in fixed bias. Net price \$51

PAK-2XM

PAK-2XM—Same as PAK-2M but has VARI-MATCH modulation output. Impedances on 3800 ohms plate to plate 380, 660, 2050, 3740, 4100, 7000, 7500, 8200, 12000, 15000, 16400, 21500, 29800. On 4000 ohm plate to plate 237, 1300, 1750, 2700, 3270, 5200. Net price \$51

Tubes required for PAK-1M and PAK-2M kits are 1-6J7, 3-6C5's, 2-6L6's, 1-83.

PAK-3M

PAK-3M—Uses 4-6L6's—70 watts self bias—100 watts fixed bias, total gain 110 DB. High impedance input. Separate chassis for power and audio for rack or cabinet mounting. Tubes are 1-6J5, 1-6C5, 2-6A5G's, 4-6L6's, 3-83's, 1-80. Output transformer impedances 500, 200, 16, 8, 5, 3, 1.5 ohms. Includes all accessories such as resistors, condensers, sockets, calibration plates, etched mixed panel, controls and accessories for a dual gain, two position high impedance mixer, chassis, dust covers, handles, hardware—except tubes—all fully mounted. Net price \$78

PAK-3XM

PAK-3XM—Same as PAK-3M but with VARI-MATCH modulation output transformer. Impedances available for fixed bias are 200, 350, 1070, 1950, 2150, 3620, 3920, 4300, 6350, 6550, 2900, 8600, 11400, 15700. For self bias 330, 580, 1800, 3250, 3550, 6100, 6500, 7100, 10400, 11000, 13000, 18600, 26000. Net price \$78

PAK-5M

PAK-5M—15 watt compact power amplifier. Uses two 6V6 Beam Power tubes. Power supply and audio amplifier on one chassis 6 x 9 x 17 inches. Tubes are 6J7, 6C5, 2-6V6's—120 DB gain. High impedance input, 500, 200, 16, 8, 5, 3, 1½ ohms output. Kit includes all accessories and pre-wired resistor—condenser strip, mixer panel, controls and accessories for a dual gain, two position mixer and VARITONE equalizer control, less tubes. Net price \$33

PAK-5XM

PAK-5XM—Same as PAK-5M but with VARI-match modulation output. Net price \$33

UNITED TRANSFORMER CORP.

72 SPRING STREET

NEW YORK, N. Y.

EXPORT DIVISION: 100 VARICK STREET

NEW YORK, N. Y. CABLES: "ARLAB"

Its performance
shouts
"Custom Built"
—yet you can
afford its price!

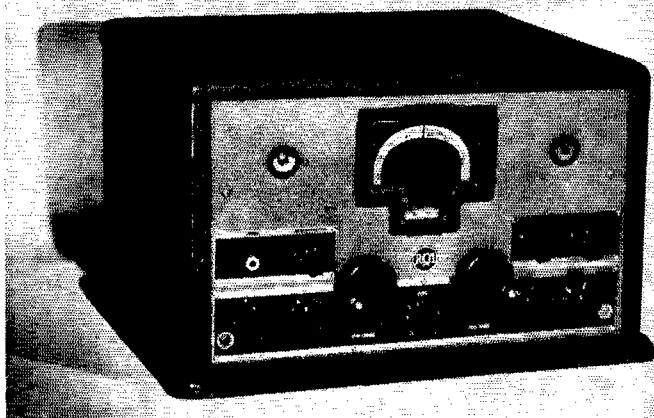

That's the ACR-111, RCA's New Communication

Receiver! *New 16-tube Amateur Receiver
meets every performance requirement of
modern operating conditions*

RCA has built a brand new communication receiver that combines "Custom Built" performance with a price you can pay. It's the sensational new ACR-111, a 16-tube instrument that offers unusually fine performance.

The exceptionally usable sensitivity of the ACR-111 is due in part to an efficiently designed antenna input system which permits the inherent sensitivity of the ACR-111 to be used—yet at the same time provides a high signal-to-noise ratio.

The selectivity of the receiver is the maximum consistent with the requirements of communication service. Frequency stability and reliability have been achieved by careful electrical circuit design and the use of rugged circuit components. Including such refinements as a noise suppressor and a constant-percentage electrical band spread system, the ACR-111 is the last word in communication receivers.

See the features in panel at right. Then visit your jobber—operate this receiver yourself and you will want to trade in your present receiver on the spot.

Amateur's net price **\$189.50 f. o. b. factory.** Write for free descriptive folder or see your supplier. Copies of operating instructions available at 25c each.

ACR-111 features that mean outstanding performance

- 16 Tubes; 14 All-Metal, 2 Glass
- 540-32,000 kcs. Continuous
- Two Tuned R-F Stages,
- Two I-F Stages
- Constant-Percentage Electrical Band Spread
- Noise Suppressor
- Noise Limiter
- Quartz Crystal I-F Filter
- Electron-Ray Tuning Tube and Signal-Strength Indicator
- Three Magnetite Core I-F Transformers
- Delayed and Amplified A.V. C.
- Unique Stand-by Pilot Light
- All Controls on Front Panel
- Separate Dust-Proof Eight-Inch Dynamic Speaker
- Band Change by Self-Cleaning Switch
- Handsome, Rugged Metal Cabinet
- Individual Dial for Each Range
- Dial Calibrated in Megacycles
- Separate Calibration-Spread Dial
- High Signal-to-Noise and Image Ratio
- Large Tuning Knobs with Crank Handles



for Amateur Radio

AMATEUR RADIO SECTION

RCA Manufacturing Co. Inc., Camden, N. J. A Service of the Radio Corporation of America